

7121335COM 70" TV Stand 2073335COM 70" Fireplace TV Stand

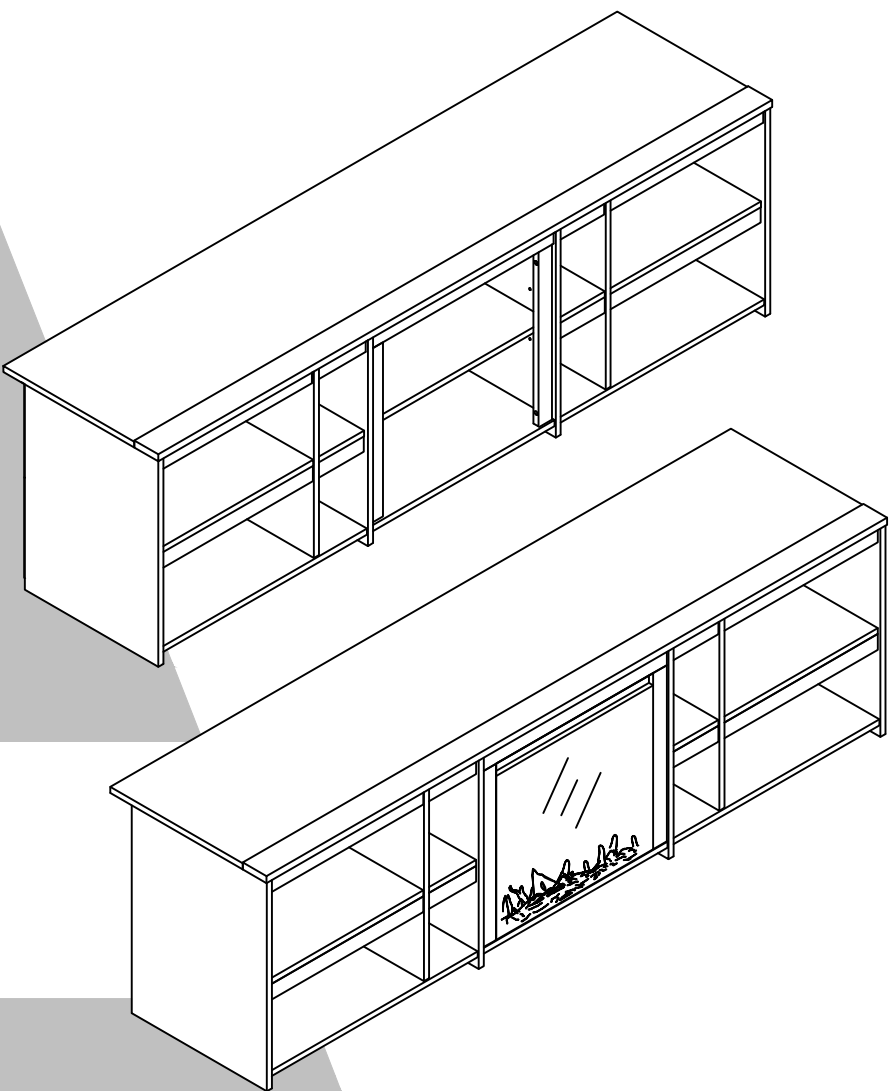

Date of Purchase ___ / ___ / ___
Lot Number:

B347121335COM00



THIS INSTRUCTION BOOKLET CONTAINS **IMPORTANT** SAFETY INFORMATION. PLEASE READ AND KEEP FOR FUTURE REFERENCE.

Do Not Return This Product!

Contact our customer service team for help first.

Call: 1-800-489-3351 (toll free)

Monday-Friday 9am - 5pm CST

Visit: www.ameriwoodhome.com

WARNING

- Unit can tip over causing severe injury or death.
- Anchor unit to stud in wall (if instructed to).
- Do Not allow children to climb on unit.
- Put heavy items on lower shelves or drawers.

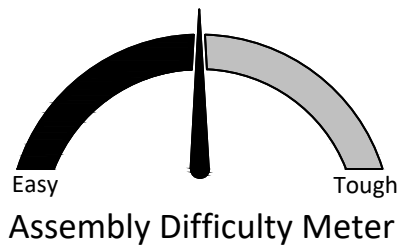

Follow Ameriwood Home



Contact Us!

Do NOT return this product!

Contact our friendly customer service team first for help.



Visit ameriwoodhome.com

Assembly Tips



Helpful Hints

PEOPLE NEEDED FOR ASSEMBLY: **1-2**
ESTIMATED ASSEMBLY TIME: **1 HOUR**

- Open your item in the area you plan to keep it to avoid excessive heavy lifting.
- Identify, sort and count the parts before attempting assembly.
- Compression dowels are lightly tapped in with a hammer.
- Slides are labeled with a **R** (right) and **L** (left) for proper placement.
- Make sure to always face the point on the top of the Cam Lock towards the outer edge.
- Use all the nails provided for the back panel and spread them out equally.
- Back panel must be used to make sure your unit is sturdy.
- Do NOT use harsh chemicals or abrasive cleaners on this item.
- Never push, pull, or drag your furniture.

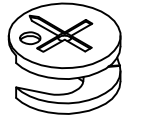

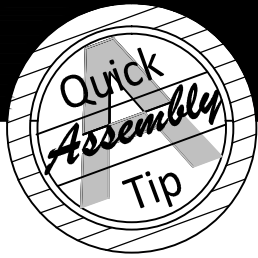

Before You Start

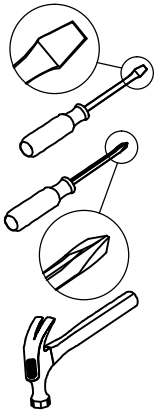

- ✓ Read through each step carefully and follow the proper order
- ✓ Separate and count all your parts and hardware
- ✓ Give yourself enough room for the assembly process
- ✓ Have the following tools: Flat Head Screwdriver, #2 Phillips Head Screwdriver and Hammer
- ✓ Caution: If using a power drill or power screwdriver for screwing, please be aware to slow down and stop when screw is tight. Failure to do so may result in stripping the screw.

Cam Lock Fastening System

This Cam Lock Fastening System will be used throughout the assembly process.

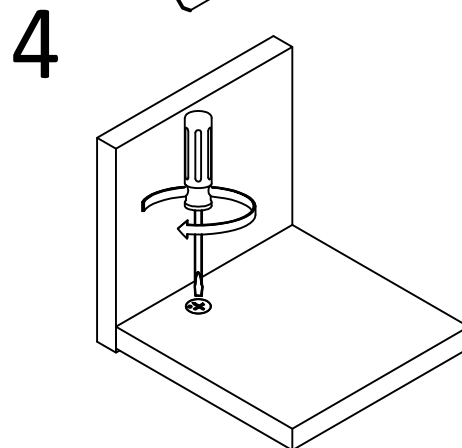
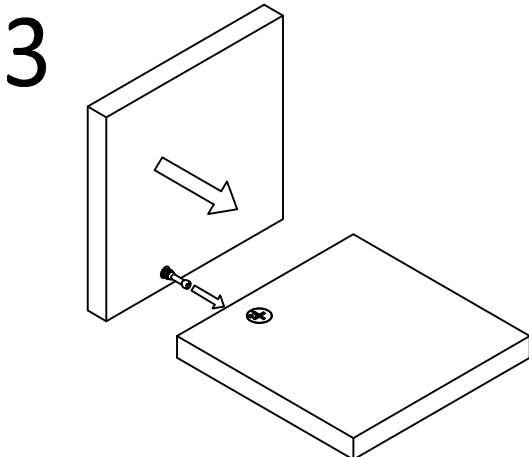
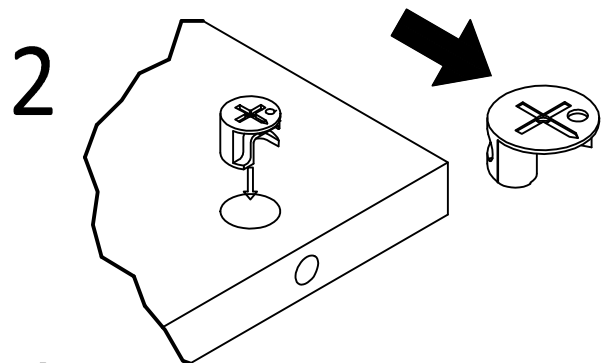
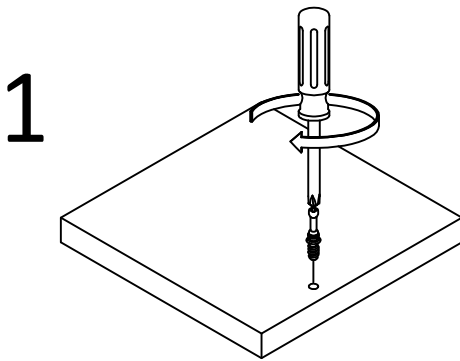

3

Board Identification

Not actual size

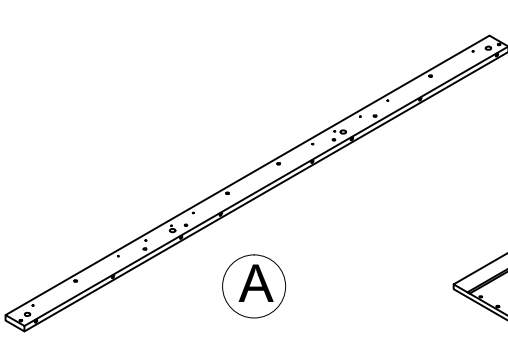

A

TOP RAIL
T7121335010CS

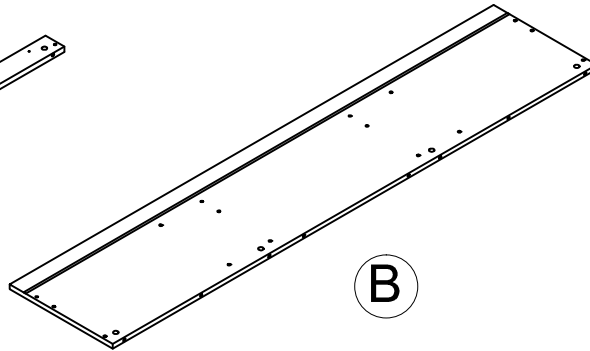

B

TOP
T7121335020CS

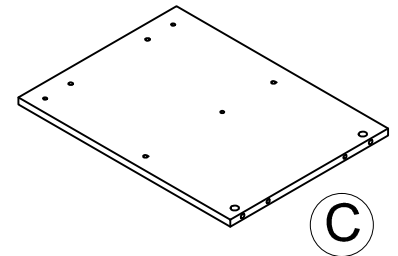

C

LEFT PANEL
T7121335030CS

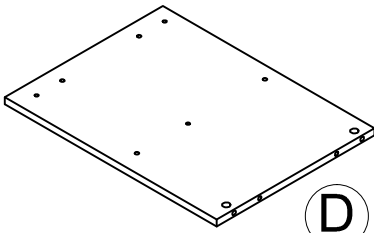

D

RIGHT PANEL
T7121335040CS

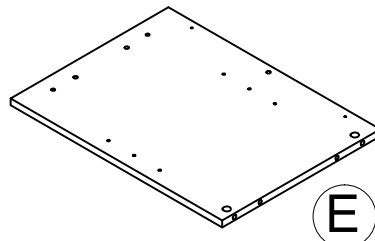

E

LEFT PARTITION
T7121335050CS

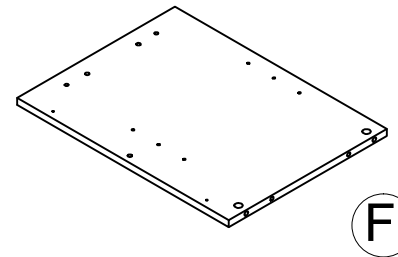

F

RIGHT PARTITION
T7121335060CS

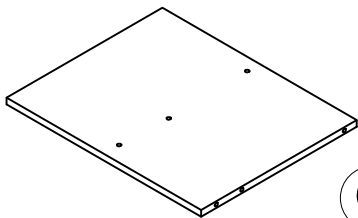

G

LEFT HUTCH PARTITION
T7121335070CS

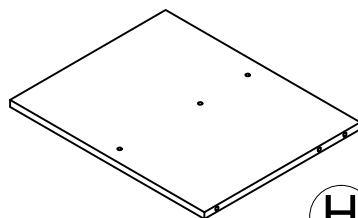

H

RIGHT HUTCH PARTITION
T7121335080CS

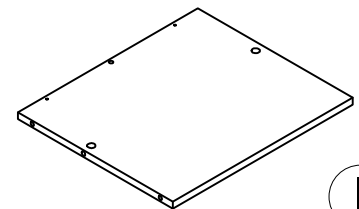

I

SHELF
T7121335090CS
QTY:2PCS

Board Identification

Not actual size

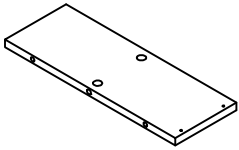

(J)

SHELF
T7121335100CS
QTY:2PCS

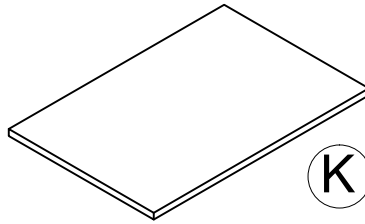

(K)

ADJUSTABLE SHELF
T7121335110CS

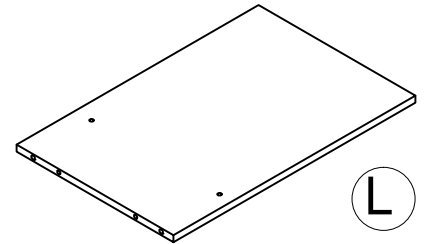

(L)

BOTTOM LEFT
T7121335120CS

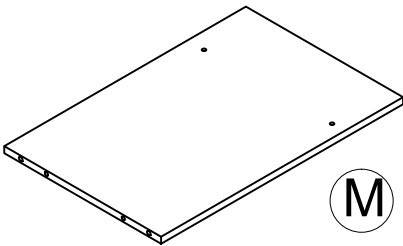

(M)

BOTTOM RIGHT
T7121335130CS

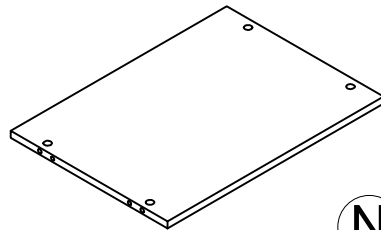

(N)

BOTTOM
T7121335140CS

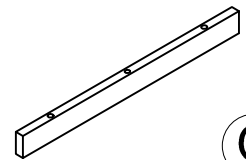

(O)

APRON
T7121335150CS
QTY:4PCS



(P)

SMALL APRON
T7121335160CS
QTY:4PCS

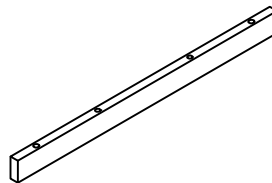

(Q)

MIDDLE APRON
T7121335170CS

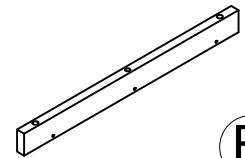

(R)

LEFT SPACER
T7121335180CS

Board Identification

Not actual size

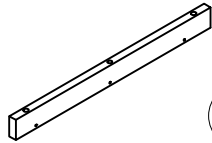

(S)

RIGHT SPACER
T7121335190CS

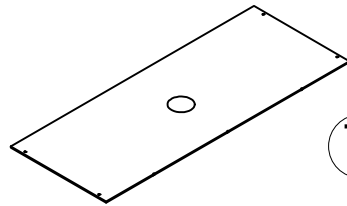

(T)

UPPER BACK PANEL
T7121335200CS
QTY:2PCS

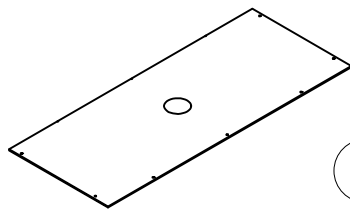

(U)

LOWER BACK PANEL
T7121335210CS
QTY:2PCS

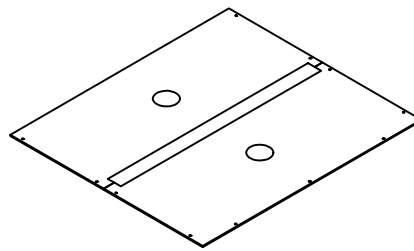

(V)

MIDDLE BACK PANEL
T7121335220CS

Part (W) included with 2073335COM only

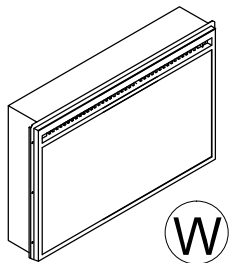

(W)

FIREPLACE INSERT
F18V66L

See the manual that came with your fireplace insert for important safety information.

Board Identification

Not actual size

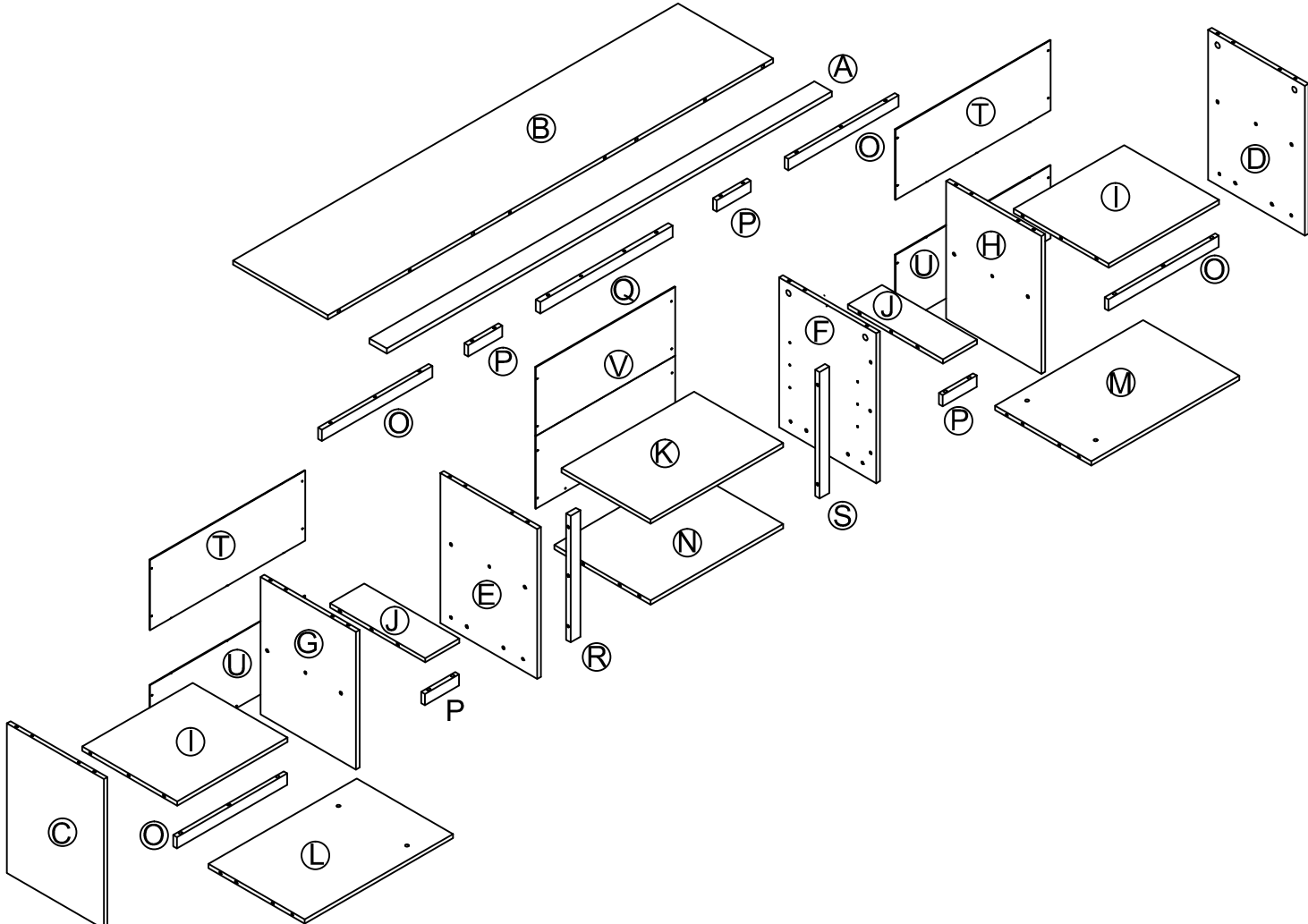

Part List

Actual Size

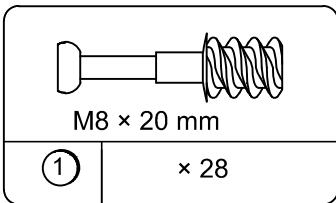

CAM BOLT
TCS2010

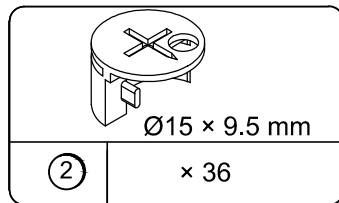

CAM LOCK
TCS2013

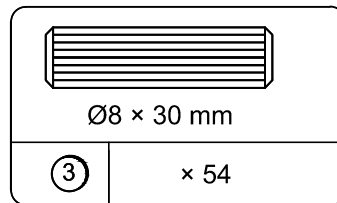

WOOD DOWEL
TCS3002

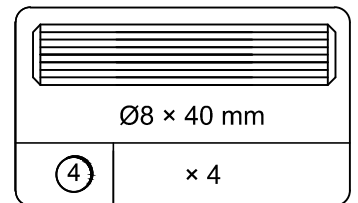

WOOD DOWEL
TCS3001

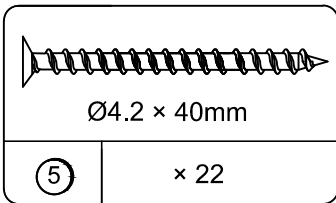

SCREW
TCS1012

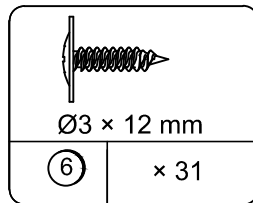

SCREW
TCS1048

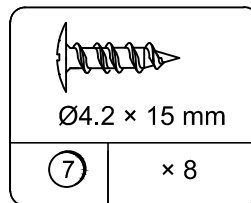

SCREW
TCS1065

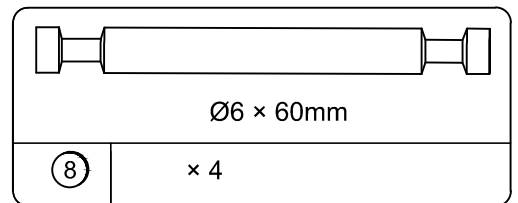

CAM BOLT
TCS2018

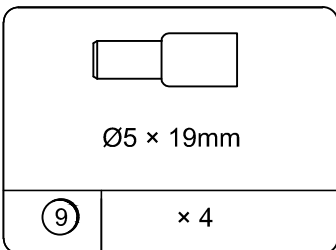

SHELF SUPPORT
TCS2009

Not Actual Size

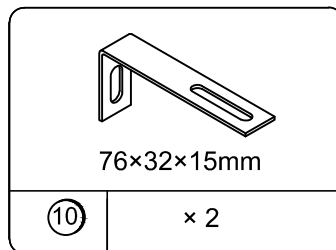

WALL BRACKET
TCS4004

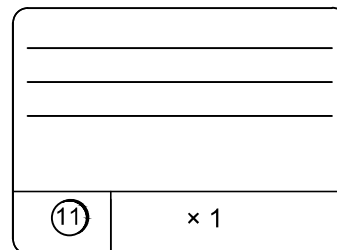

WARNING LABEL
TCS3311

STEP 1

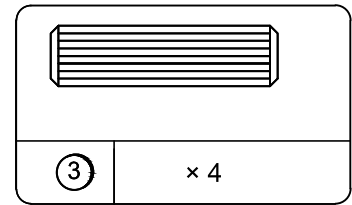
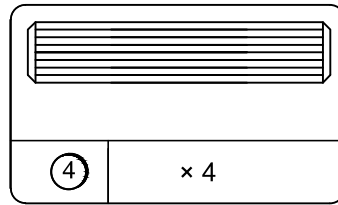
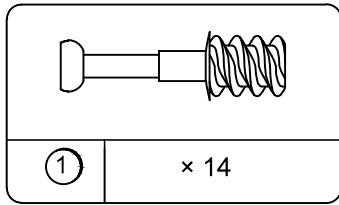
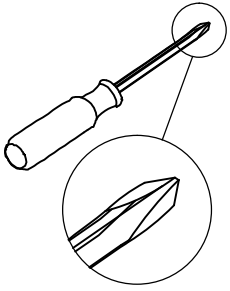

- 1.1 Screw (1) into (A), (B), (C) & (D) as illustrated.
- 1.2 Insert (3) into (C) & (D) as illustrated.
- 1.3 Insert (4) into (B) as illustrated.

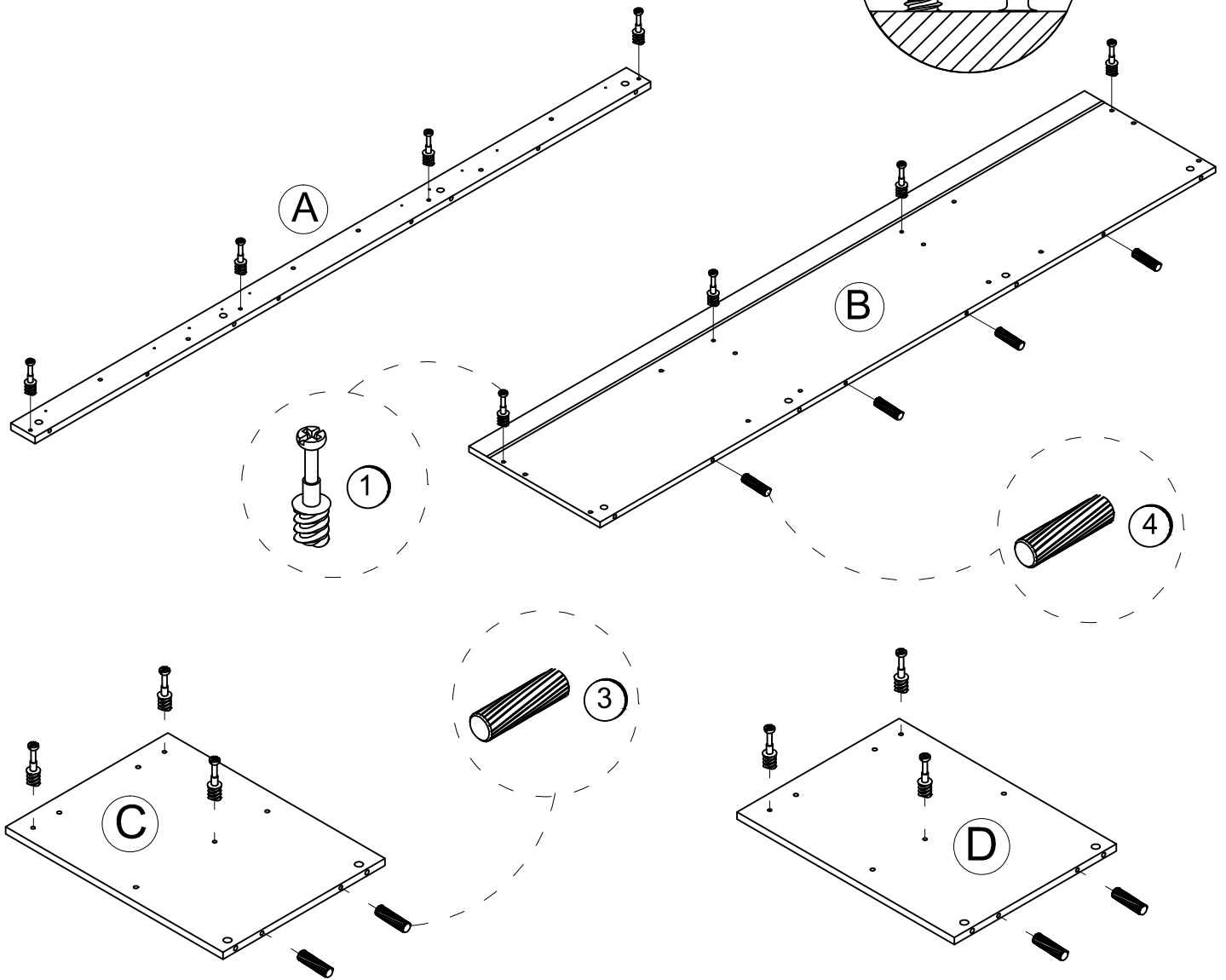
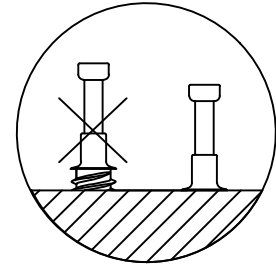

STEP 2

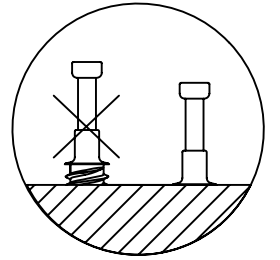
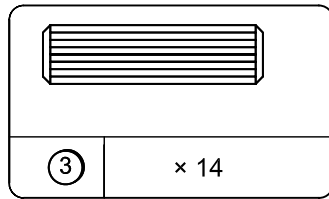
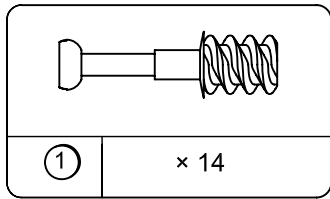
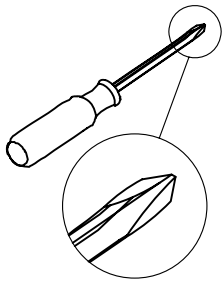

2.1 Screw (1) into (E), (F), (G) & (H) as illustrated.
 2.2 Insert (3) into (E), (F), (G) & (H) as illustrated.

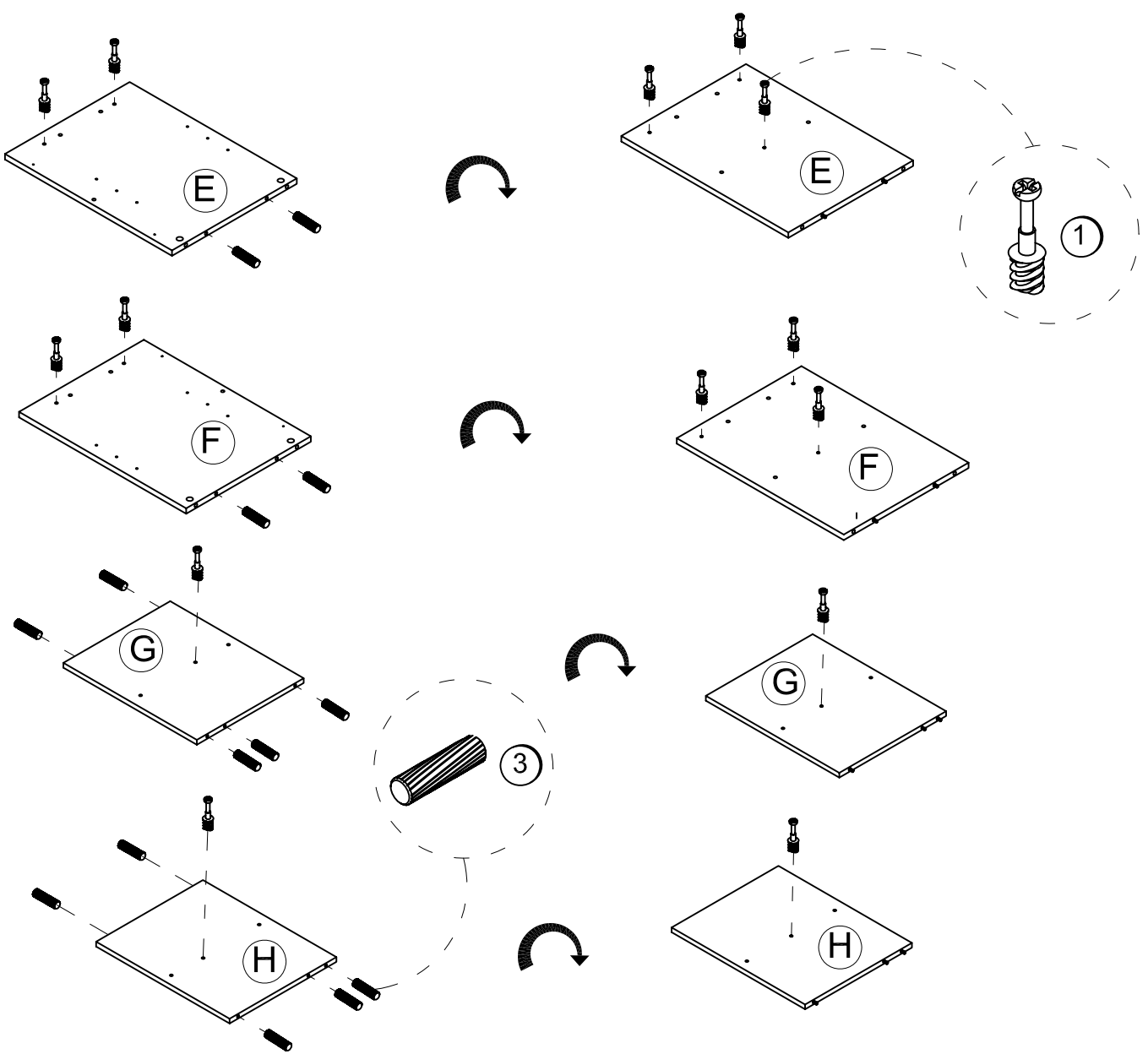

STEP 3

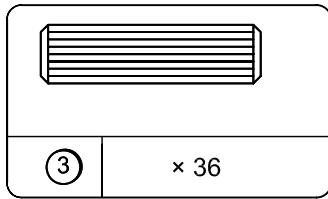

3.1 Insert (3) into (I), (J), (L), (M), (N), (O), (Q), (R) & (S) as illustrated.

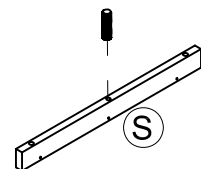
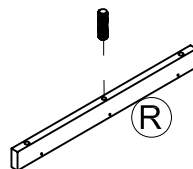
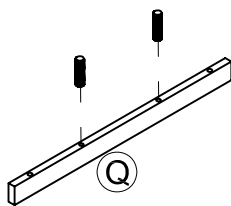
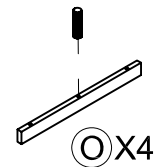
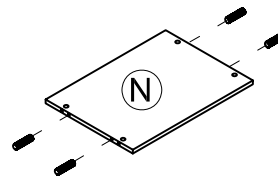
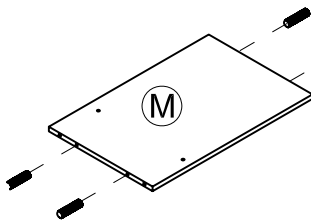
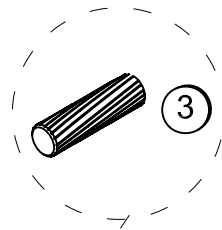
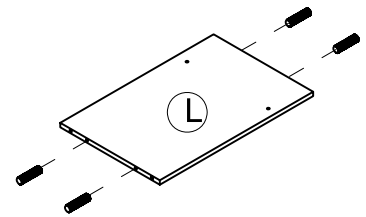
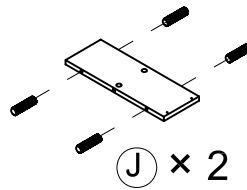
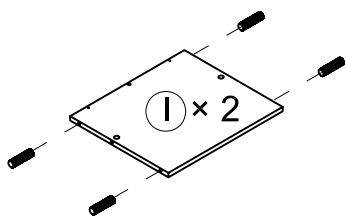

STEP 4

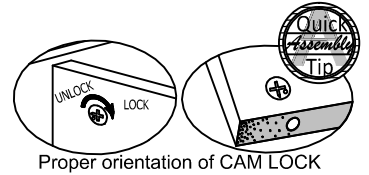
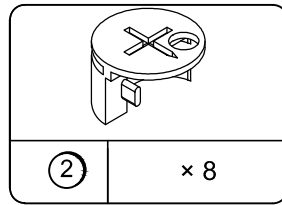
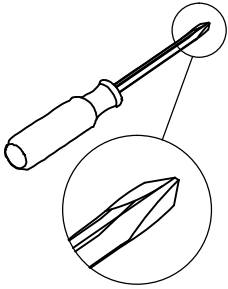

4.1 Attach (A) to (B) with (2) & (8) as illustrated.

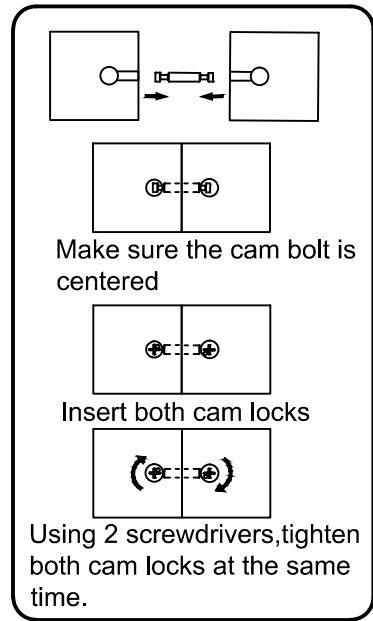
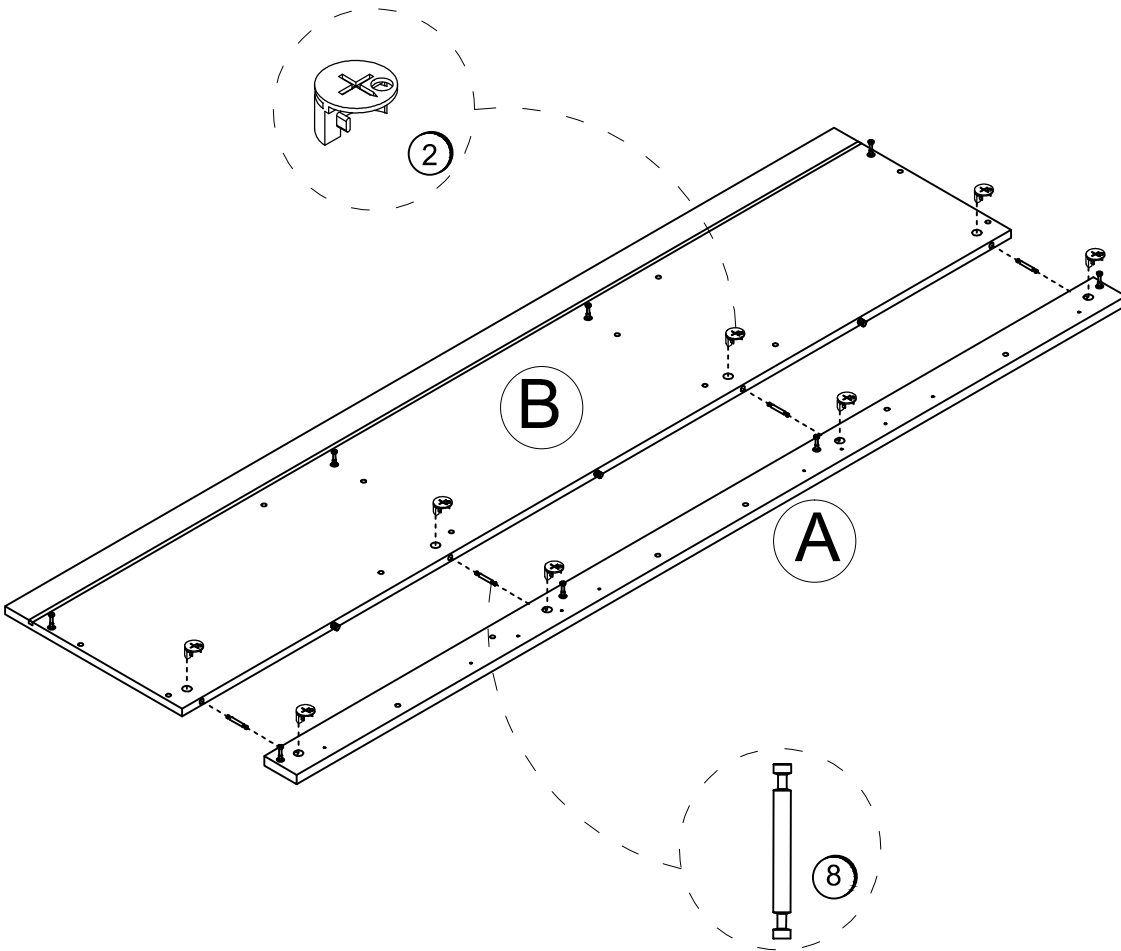

STEP 5

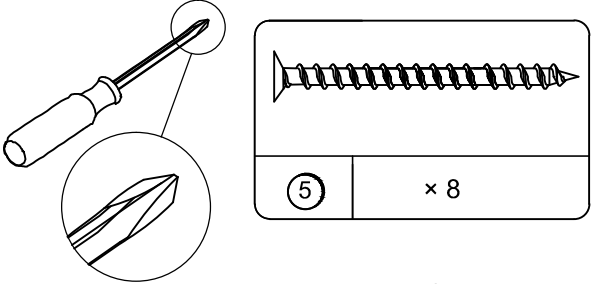

5.1 Attach (O) to (I) with (5) as illustrated.
5.2 Attach (P) to (J) with (5) as illustrated.

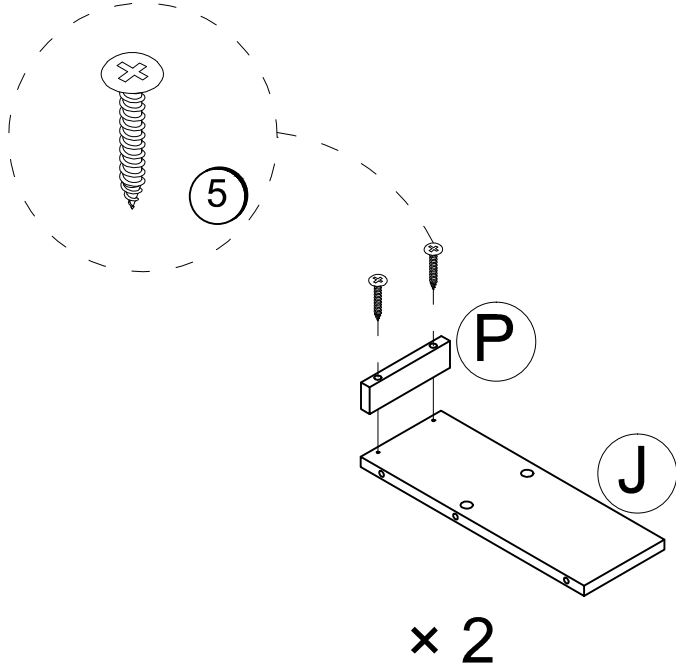
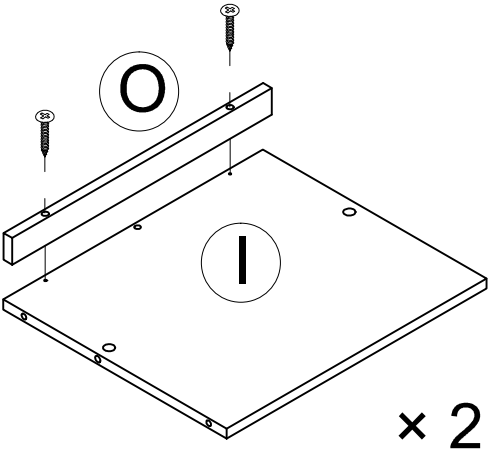

STEP 6

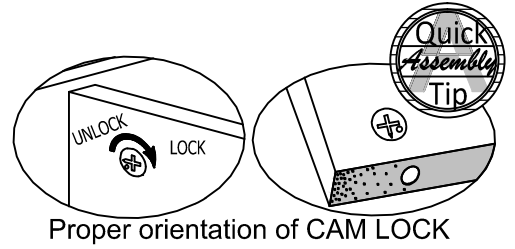
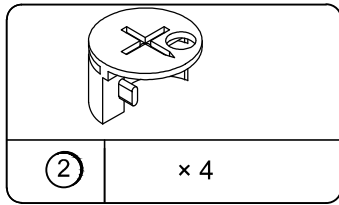
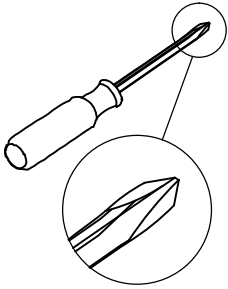

- 6.1 Connect (G), (I), (J) & (L) together with (2) as illustrated.
 6.2 Connect (H), (I), (J) & (M) together with (2) as illustrated.

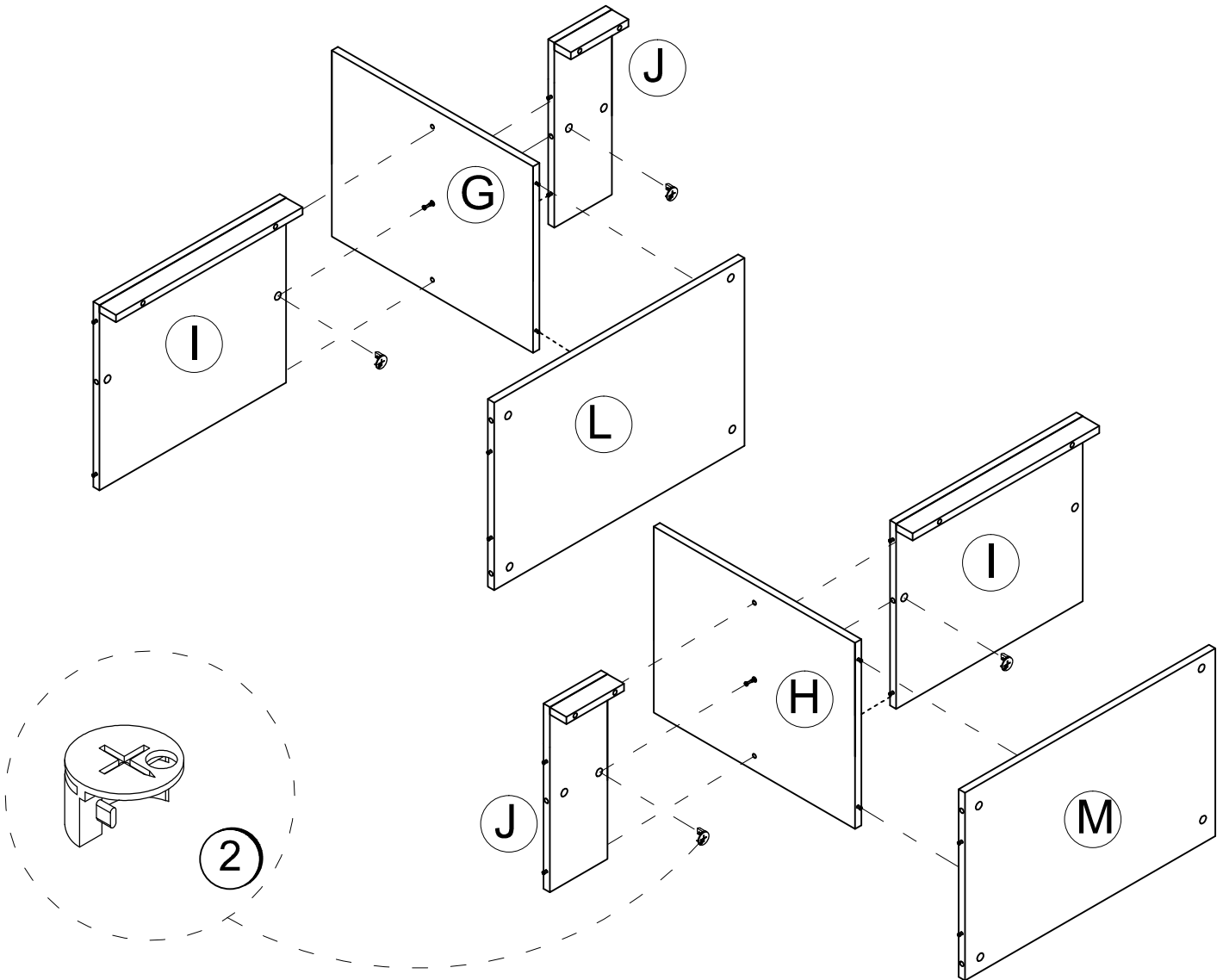

STEP 7

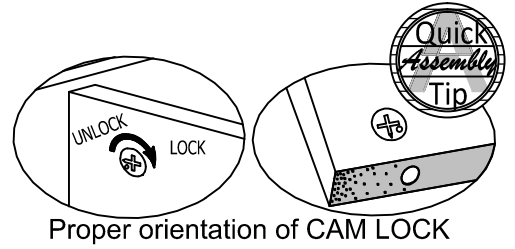
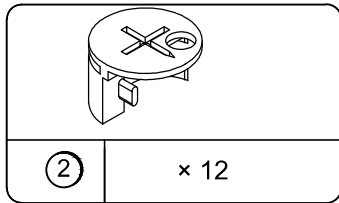
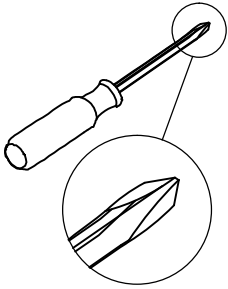

- 7.1 Attach (C) to (I) & (L) with (2) as illustrated.
- 7.2 Attach (E) to (J) & (L) with (2) as illustrated.
- 7.3 Attach (F) to (J) & (M) with (2) as illustrated.
- 7.4 Attach (D) to (I) & (M) with (2) as illustrated.

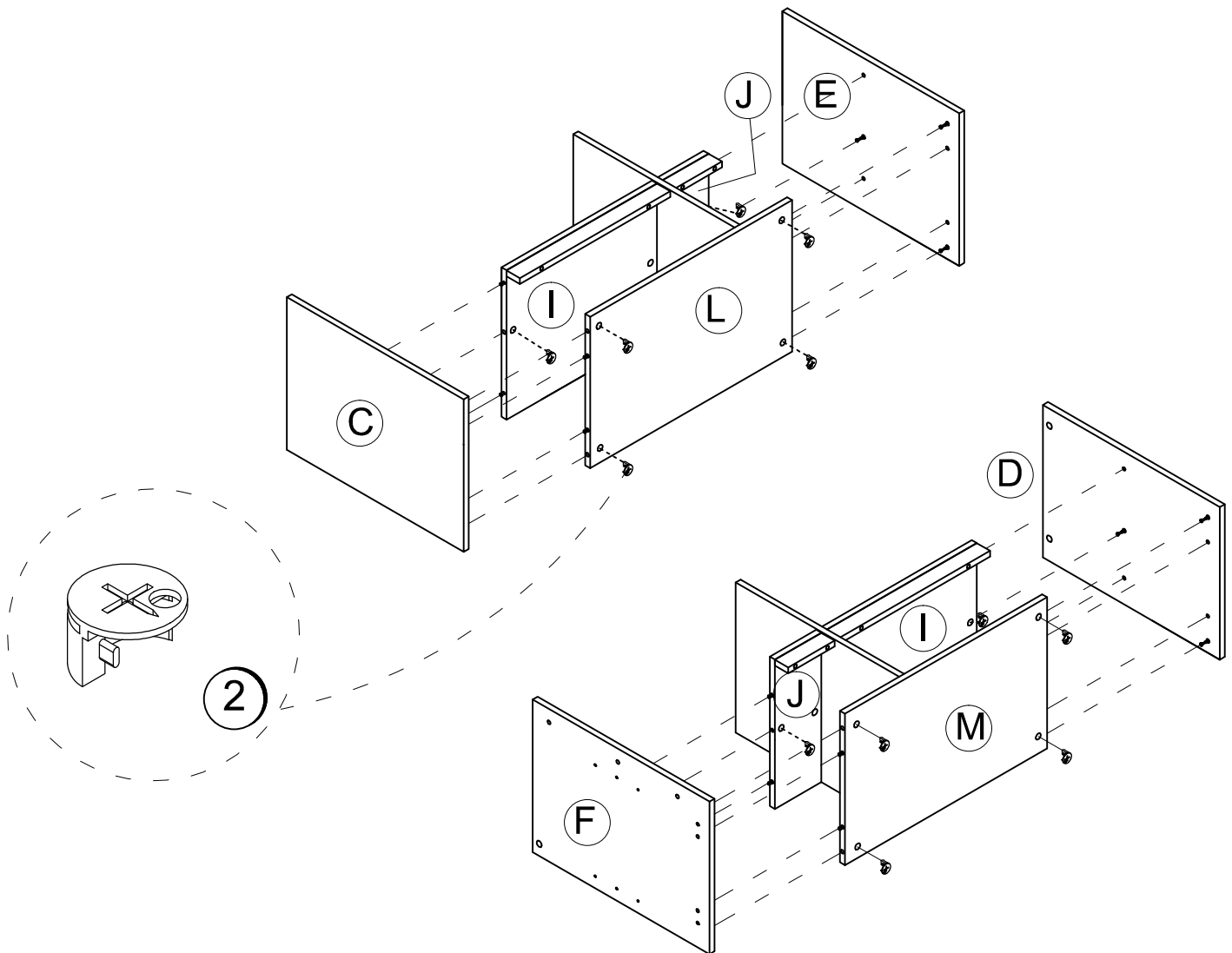

STEP 8

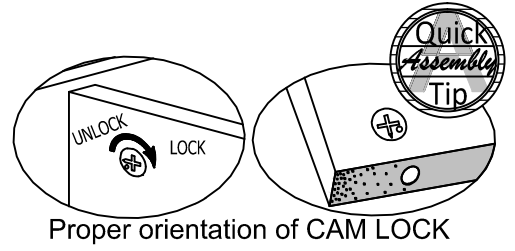
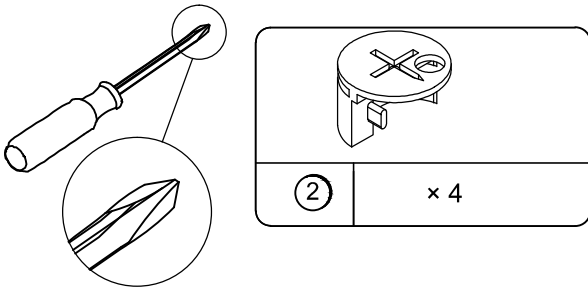

8.1 Connect (E), (F) & (N) with (2) as illustrated.

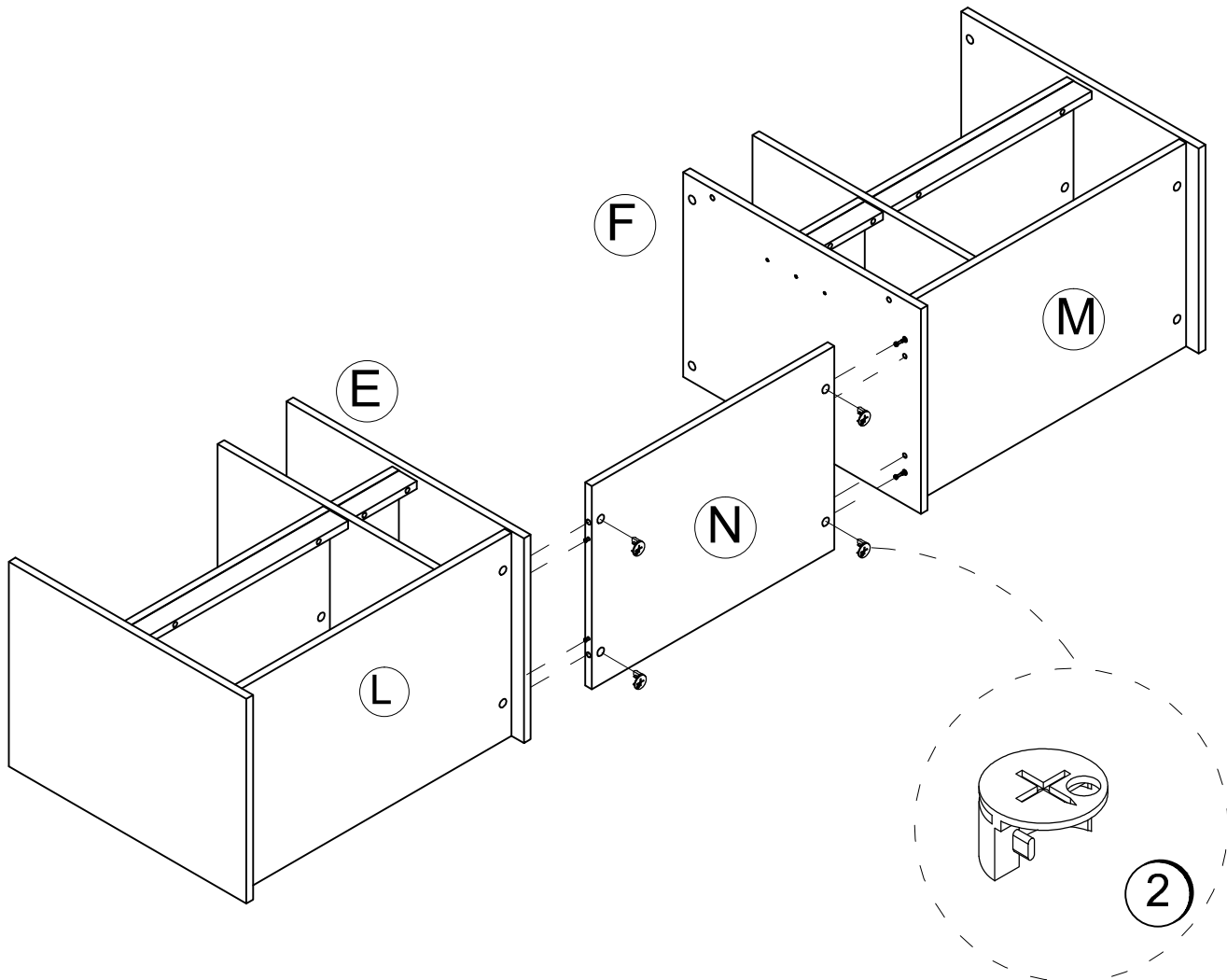

STEP 9

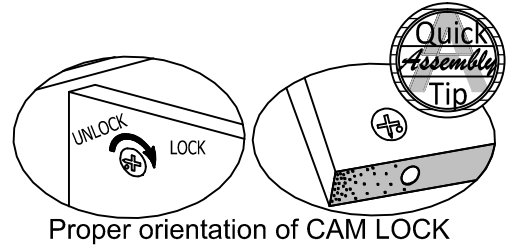
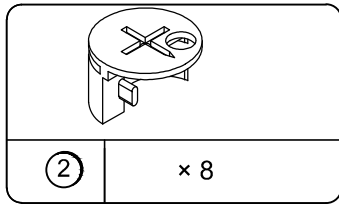
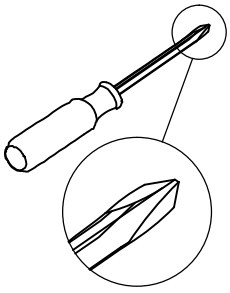

Proper orientation of CAM LOCK

9.1 Attach (A) & (B) to (C), (D), (E) & (F) with (2) as illustrated.

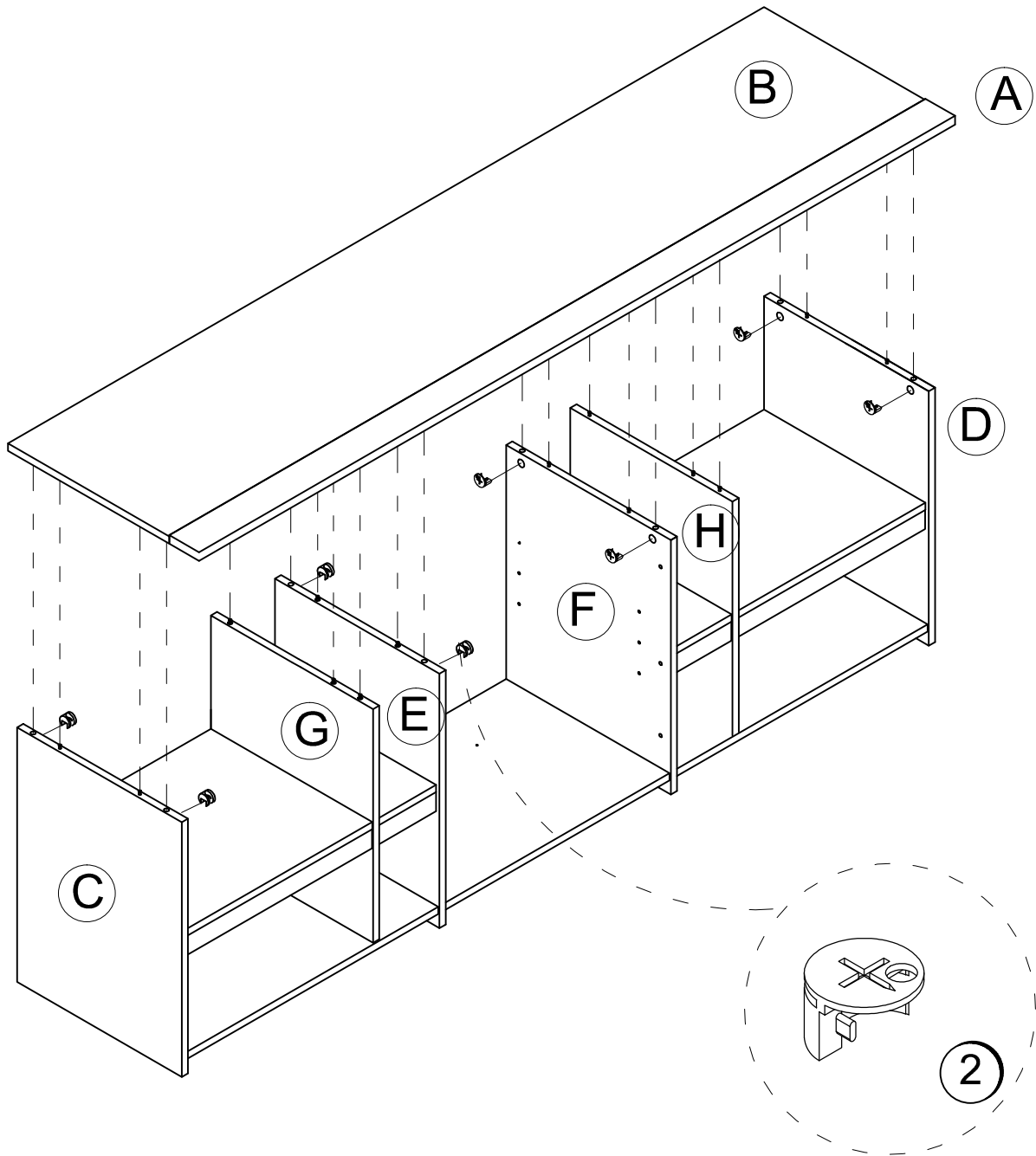

STEP 10

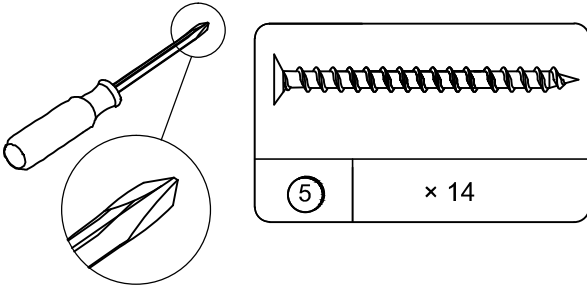

- 10.1 Attach (O), (P) & (Q) to (A) with (5) as illustrated.
- 10.2 Attach (R) to (E) with (5) as illustrated.
- 10.3 Attach (S) to (F) with (5) as illustrated.

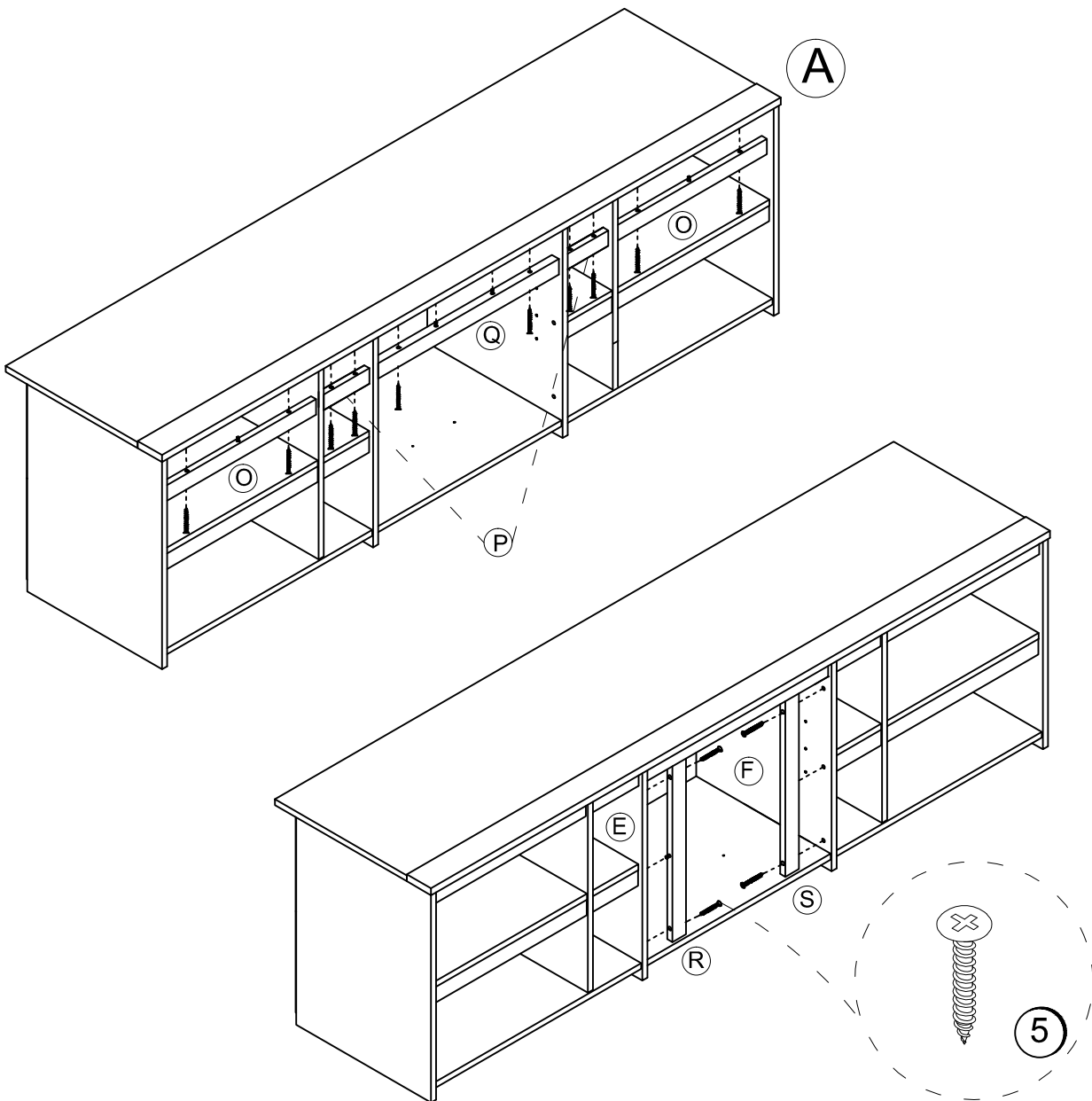

If you purchased the TV Stand with the fireplace insert, skip this step and proceed to step 13.

STEP 11

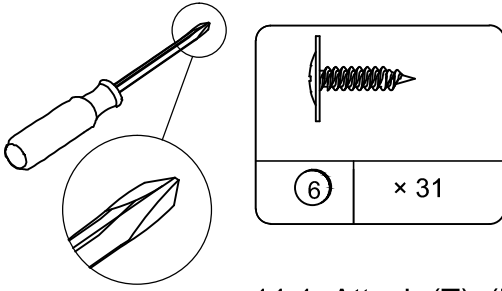

11.1 Attach (T), (U) & (V) to sub-assembly with (6) as illustrated.

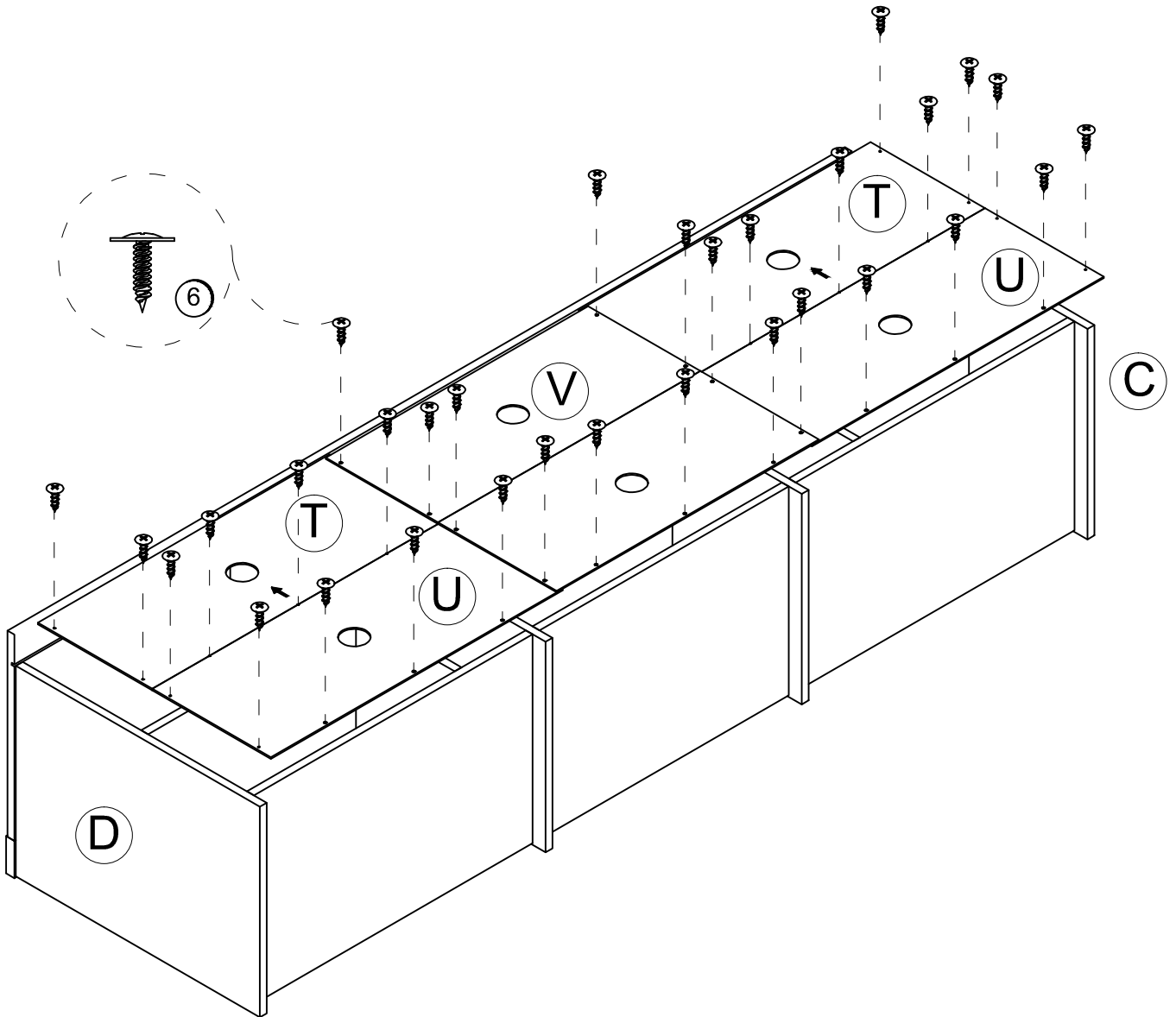

If you purchased the TV Stand with the fireplace insert, skip this step and proceed to step 13.

STEP 12

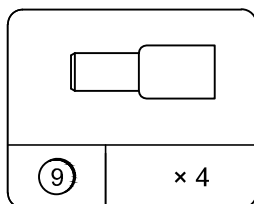

12.1 Insert (K) to (E) & (F) with (9) as illustrated.

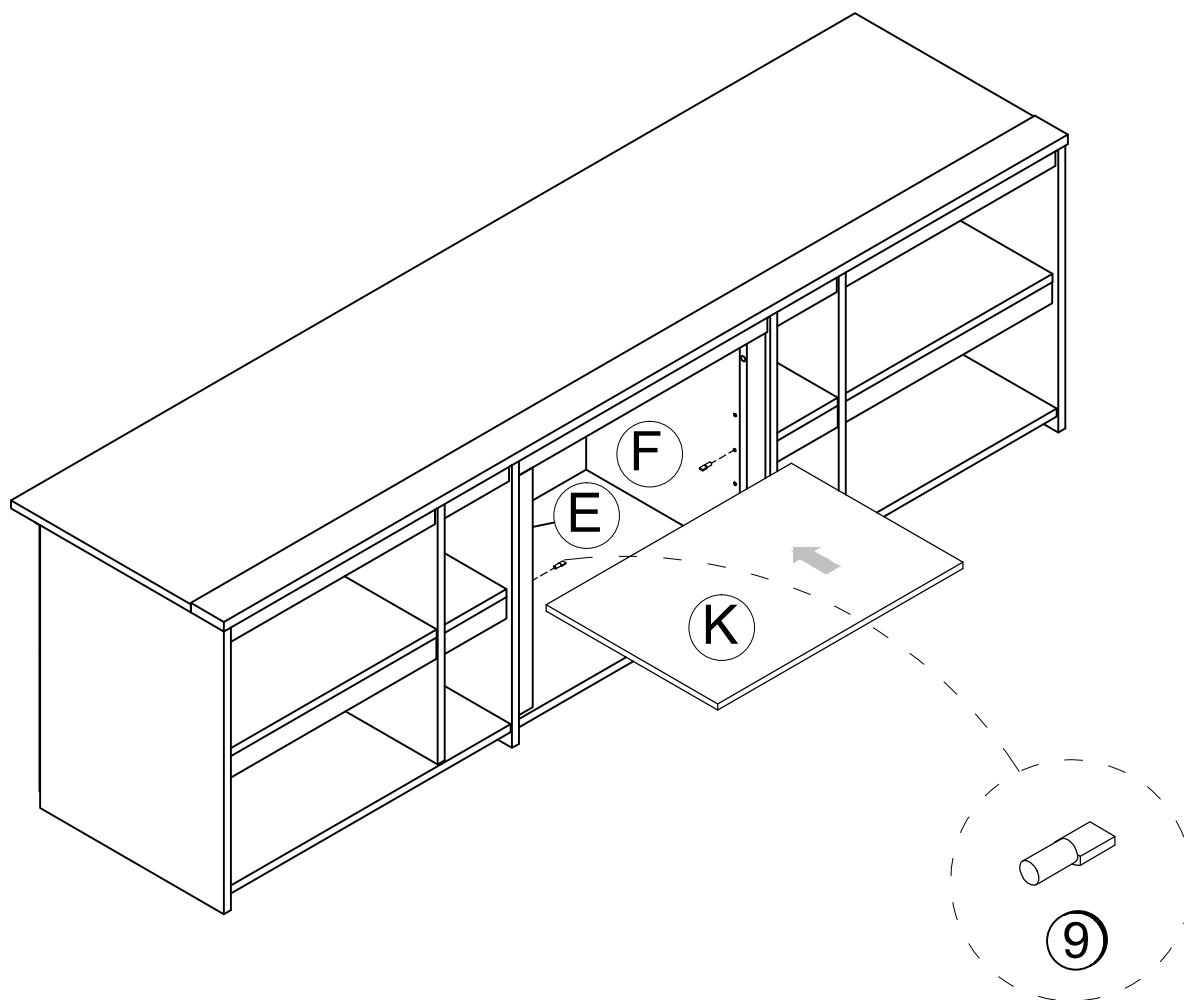

STEP 13

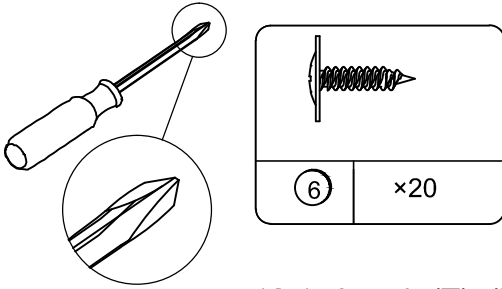

13.1 Attach (T), (U) to sub-assembly with (6) as illustrated.

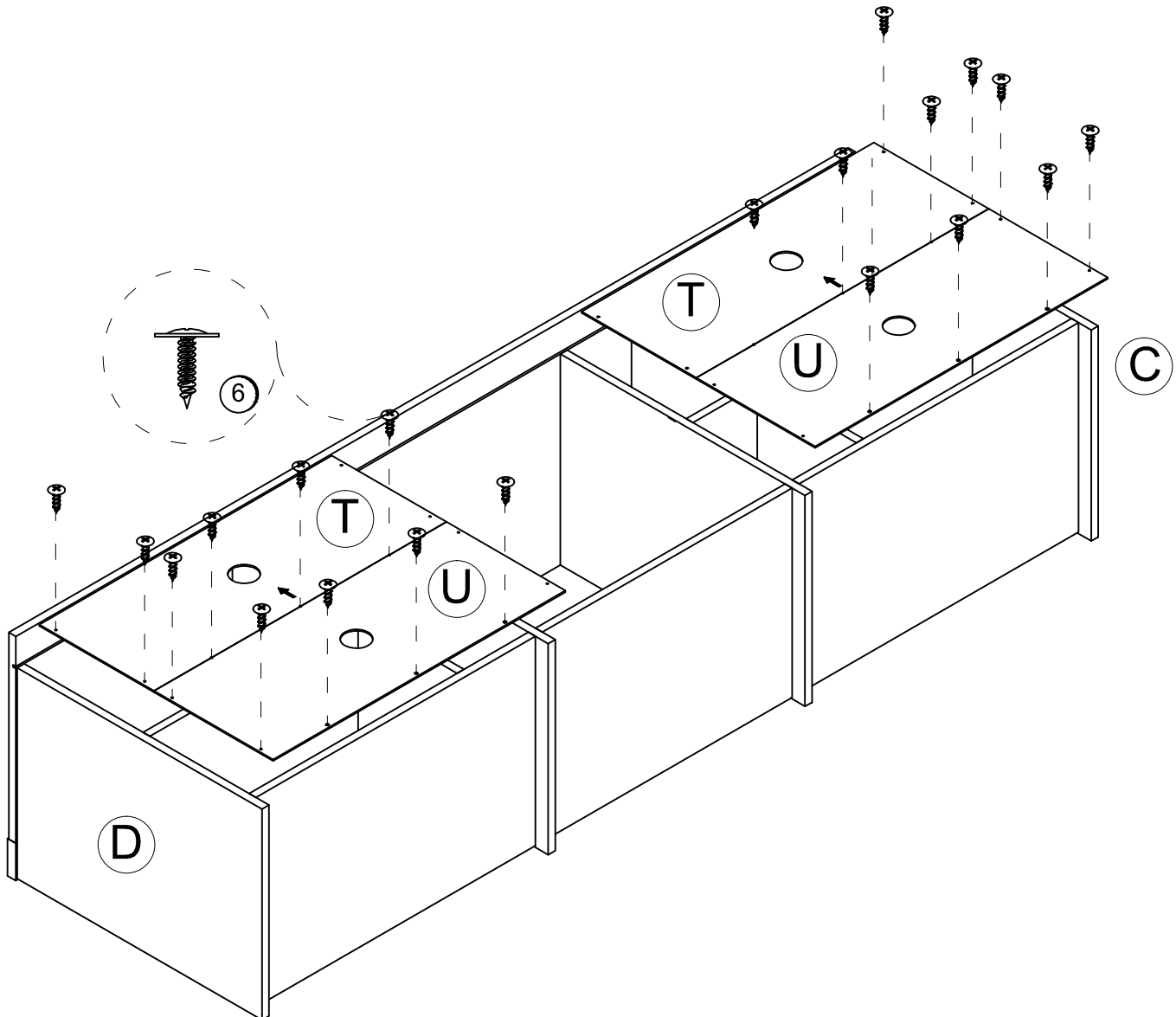

STEP 14

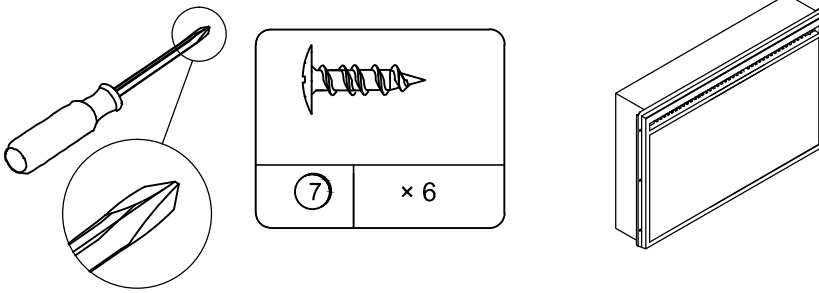

14.1 Attach fireplace to (R) & (S) with (7) as illustrated.

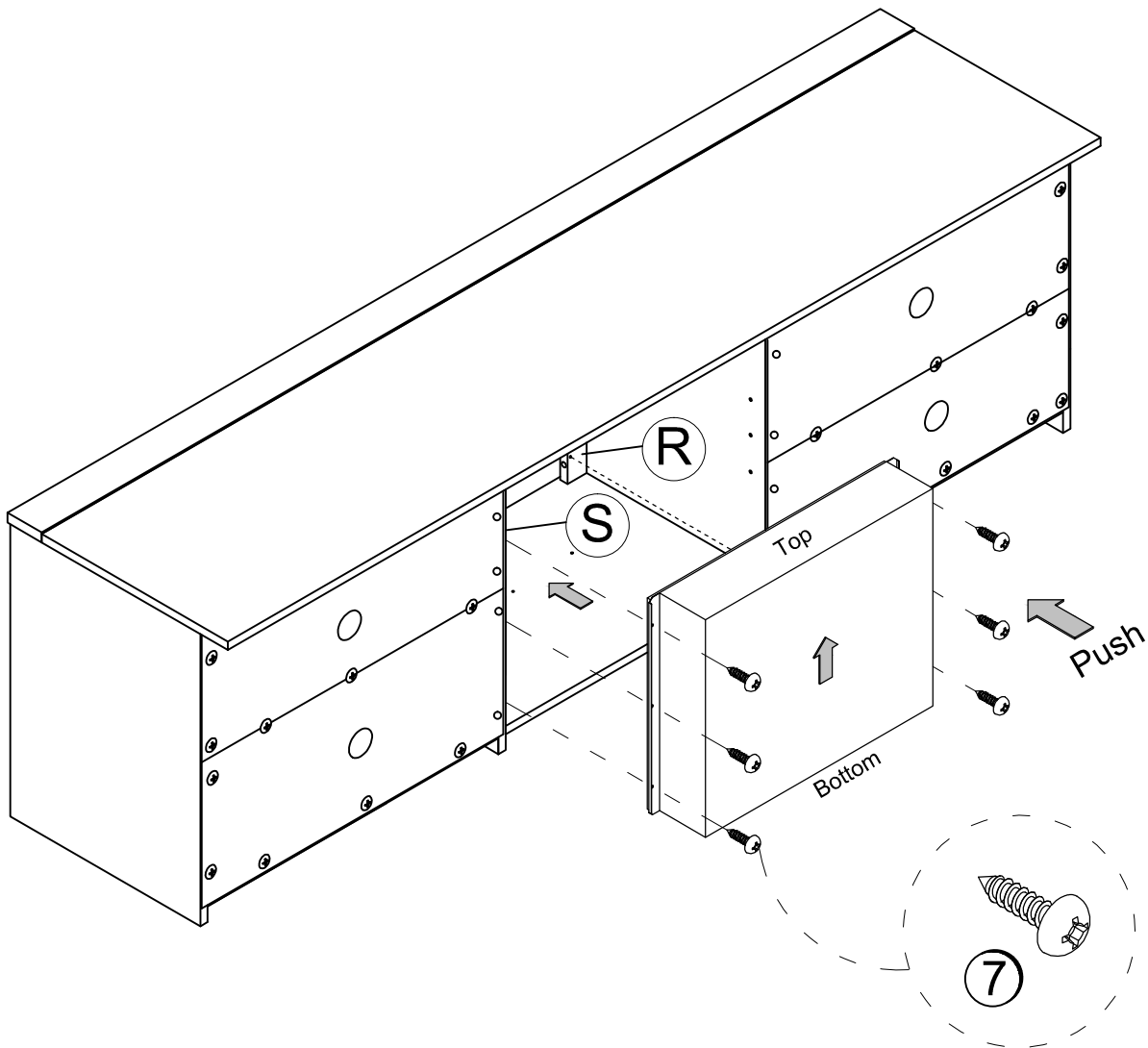

STEP 15

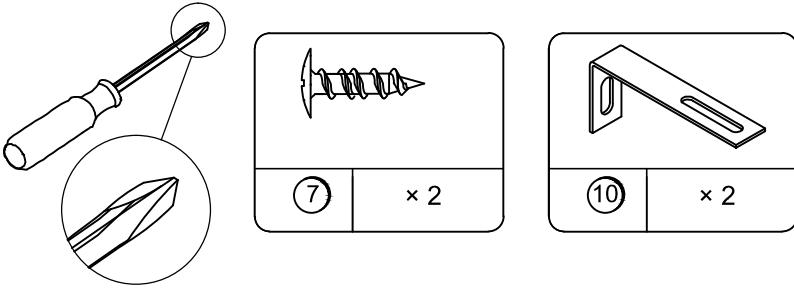

15.1 Attach (10) to (N) with (7) as illustrated.

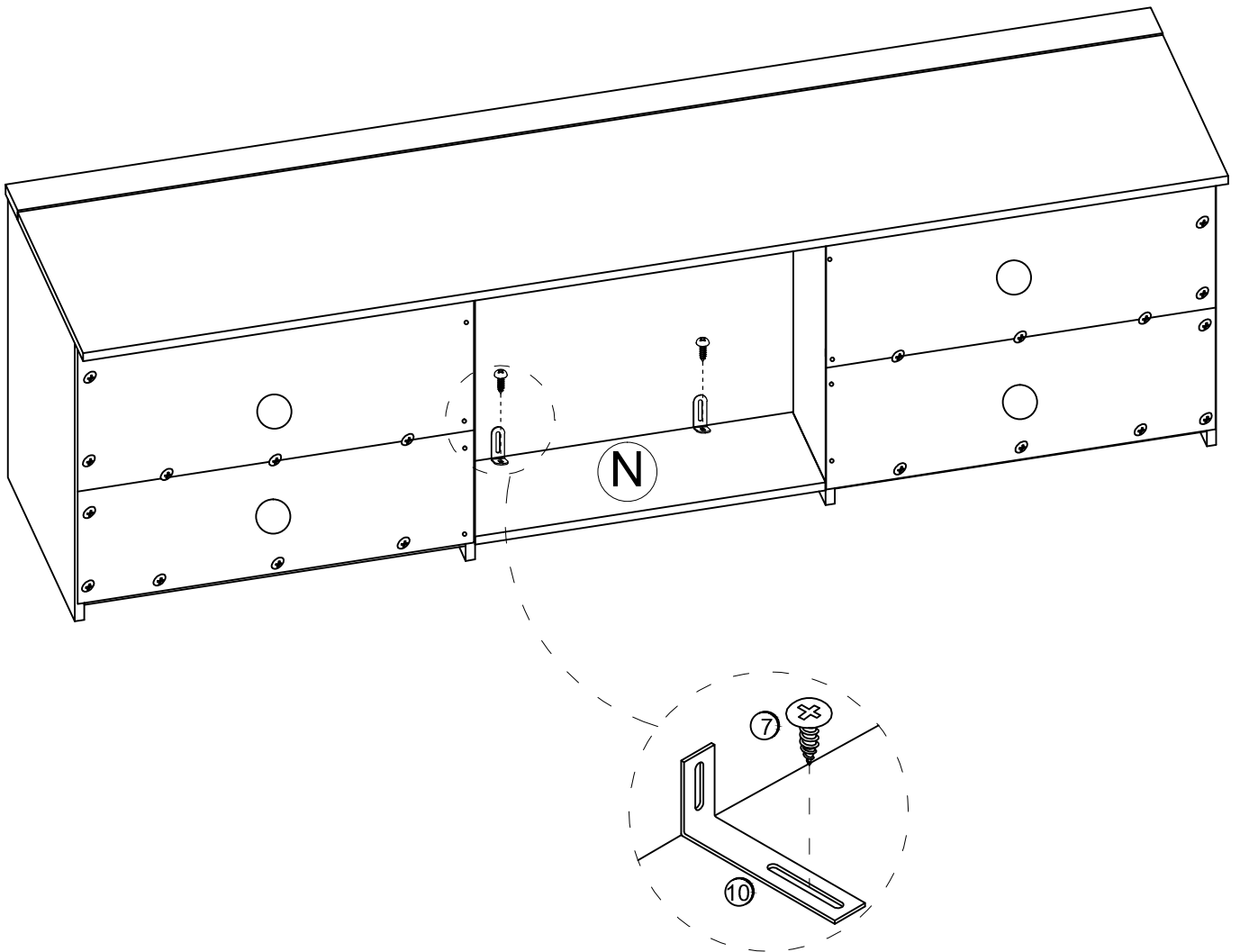

STEP 16

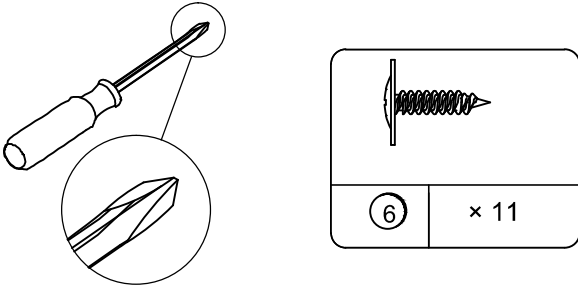

16.1 Attach (V) to sub-assembly with (6) as illustrated.

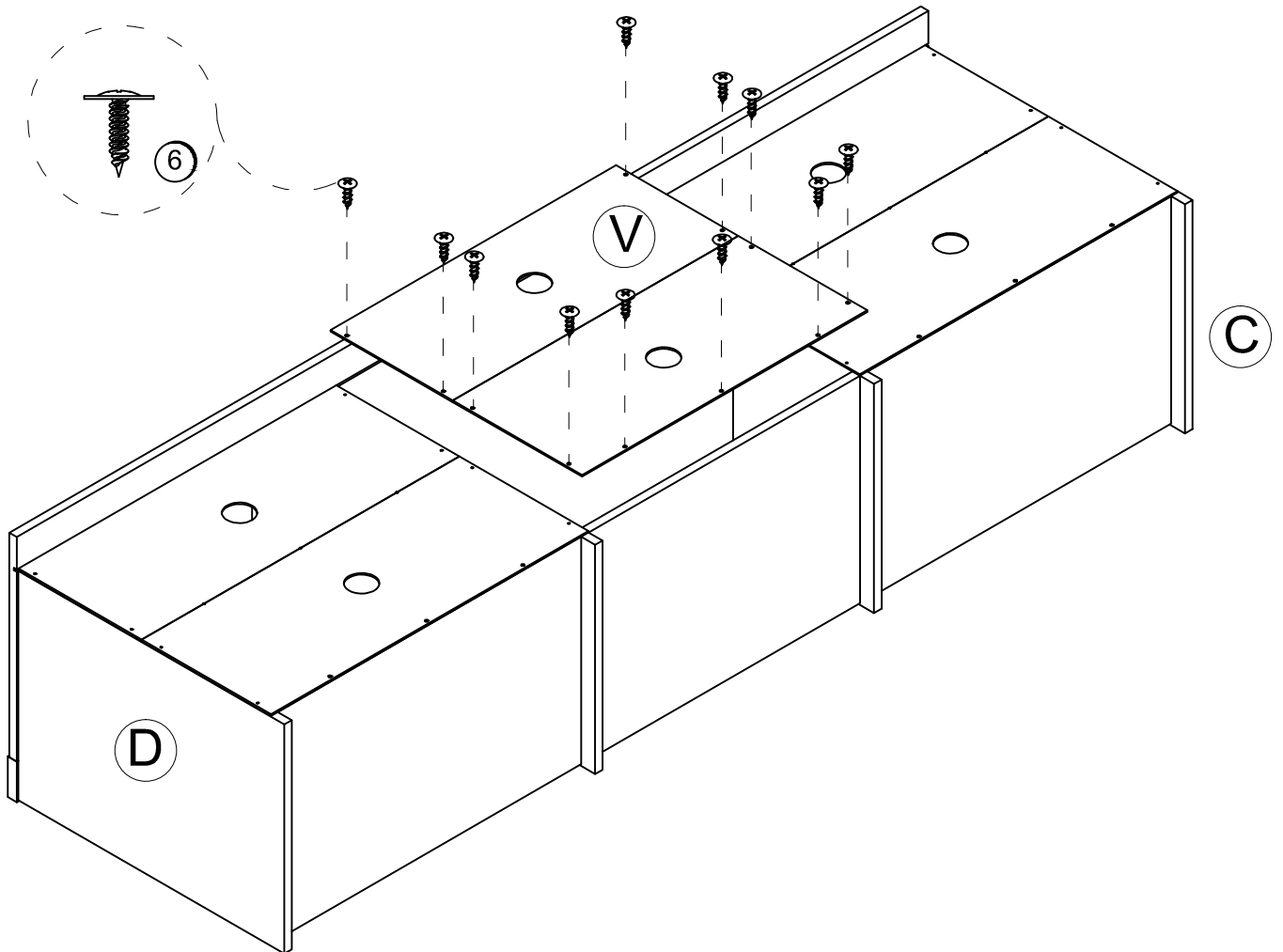

STEP 17

WARNING

IF THE INFORMATION IN THE FIREPALCE OPERATING MANUAL IS NOT FOLLOWED, AN ELECTRIC SHOCK OR FIRE MAY RESULT IN PROPERTY DAMAGE, PERSONAL INJURY , OR LOSS OF LIFE .

WARNING

Risk of death or serious injury. This unit must be placed against a fixed in place wall at least as tall as television.

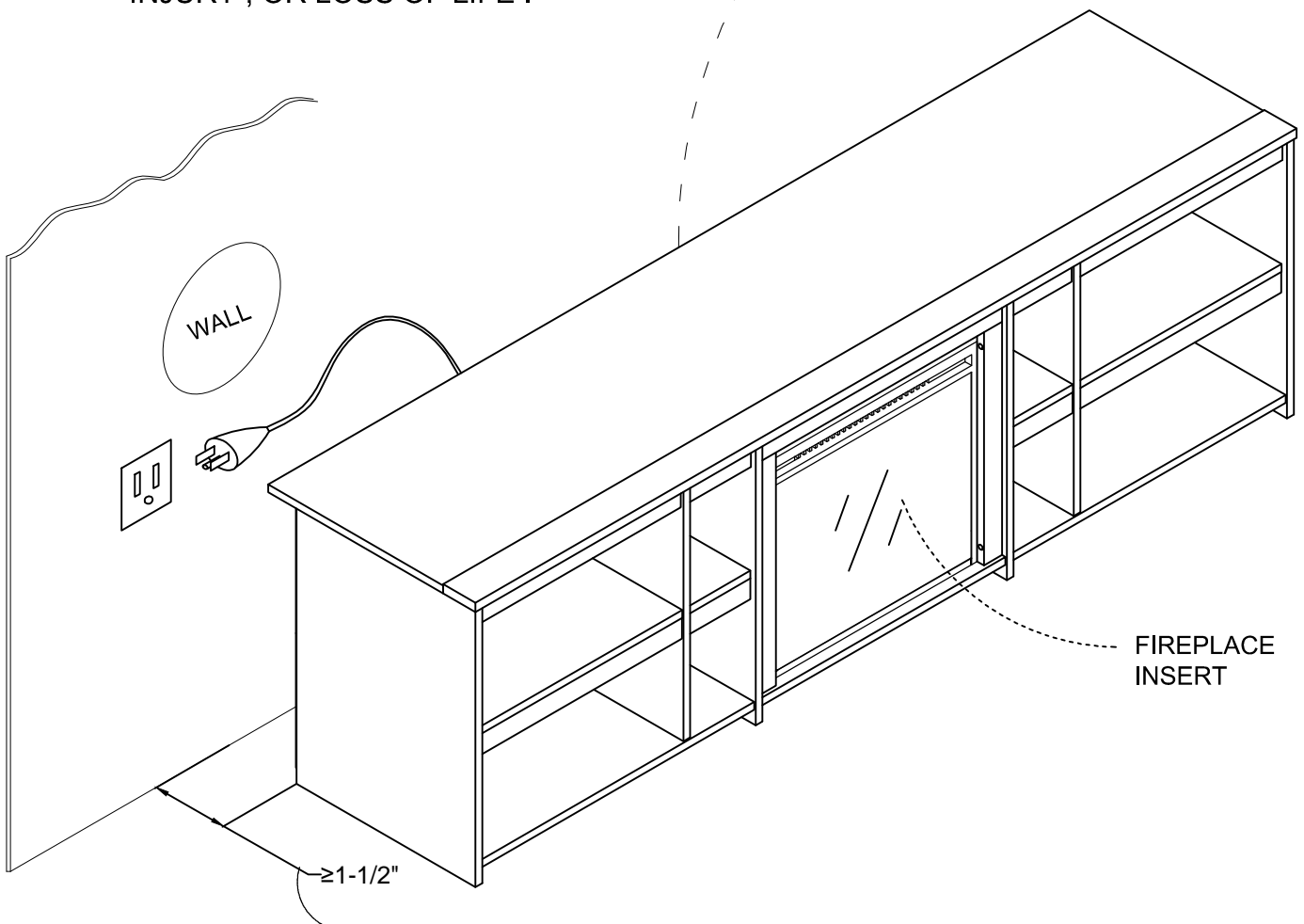

To allow proper heater ventilation, this unit must be located a minimum of 1-1/2" away from a back wall.

Maximum Loads

This unit has been designed to support the maximum loads shown. Exceeding these load limits could cause sagging, instability, product collapse, and/or serious injury.

Notice: Please apply the TV warning label to your unit so you'll always have the model's weight and TV size limits.

Maximum TV size: 70" flat screen

MAKE SURE TO PLACE THE TV BEHIND THIS TOP RAIL

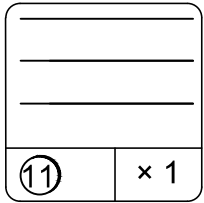

WARNING LABEL
TCS3311

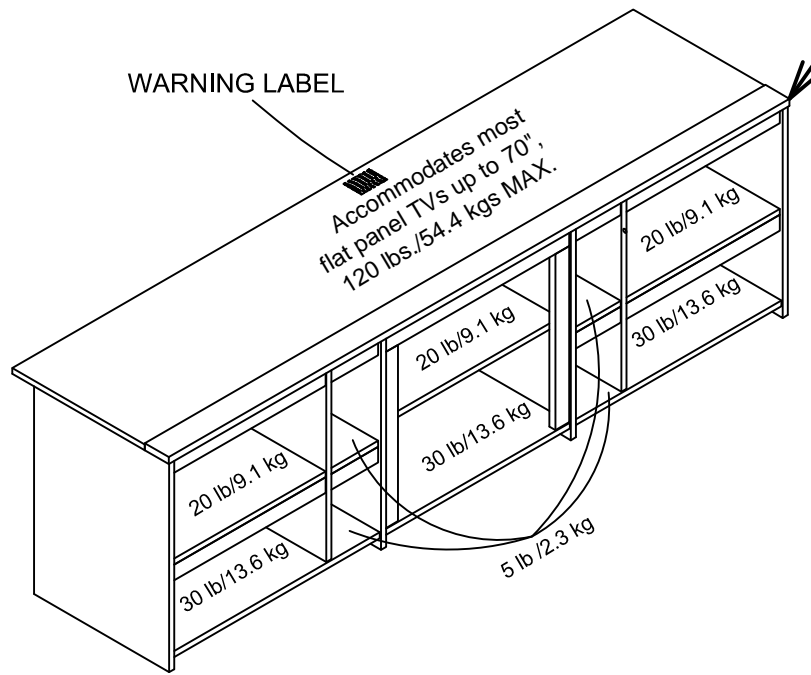

Apply the warning label to the center of the top panel as shown, ensure the TV covers the label in use. You will not be able to remove the label after it is applied to the top panel.

Certificate of Conformity

1. This certificate applies to the Dorel Home Furnishings, Inc. product identified by this instruction manual.
2. This certificate applies to compliance of this product with the CPSC Ban on Lead-Containing Paint (16 CFR 1303).
3. This product is distributed by: Dorel Home Furnishings, Inc.
410 East First Street South
Wright City, MO 63390
636-745-3351
4. Site of Manufacture: Fujian China
5. See front page of instruction manual for date of manufacture.

Maximum Loads

This unit has been designed to support the maximum loads shown. Exceeding these load limits could cause sagging, instability, product collapse, and/or serious injury.

Notice: Please apply the TV warning label to your unit so you'll always have the model's weight and TV size limits.

Maximum TV size: 70" flat screen

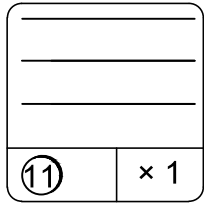

WARNING LABEL
TCS3311

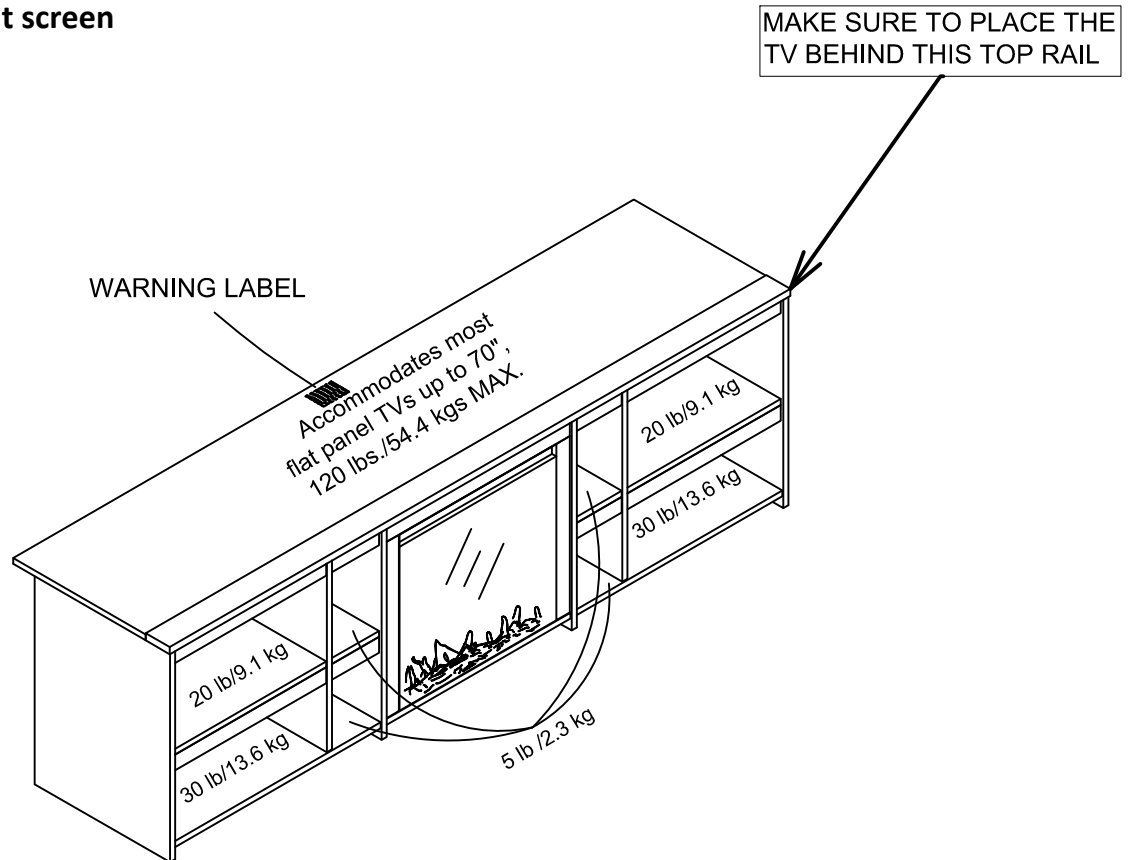

Apply the warning label to the center of the top panel as shown, ensure the TV covers the label in use. You will not be able to remove the label after it is applied to the top panel.

Certificate of Conformity

1. This certificate applies to the Dorel Home Furnishings, Inc. product identified by this instruction manual.
2. This certificate applies to compliance of this product with the CPSC Ban on Lead-Containing Paint (16 CFR 1303).
3. This product is distributed by: Dorel Home Furnishings, Inc.
410 East First Street South
Wright City, MO 63390
636-745-3351
4. Site of Manufacture: Fujian China
5. See front page of instruction manual for date of manufacture.

Register your product to receive the following:



- * New trend details - sneak peek on what's new
- * Surveys - have a voice within our community
- * Exclusive deals and discount codes
- * Quick and easy replacement part service

To register your product, visit ameriwoodhome.com

5 Star Rating



Visit your local retailer's website, rate your purchased product and leave us some feedback!

We would like to extend a big "Thank You" to all of our customers for taking the time to assemble this Ameriwood Home product, and to give us your valuable feedback.

*Thank
You!*

Cubierta Delantera

Este libro de instrucciones contiene información **IMPORTANTE** de seguridad. Por favor lea y manténgalo para referencia en el futuro.

No Regrese este producto! Comuníquese con nuestro amigoso equipo de servicio al cliente para obtener ayuda.

Llámenos al: 1-800-489-3351 (Gratis) Lunes - Viernes 9am - 5pm CST

Visitar: www.ameriwoodhome.com

PRECAUCION

Este mueble puede volcarse y causar graves heridas y/o muerte.

Anclar el mueble a un poste de madera en la pared (si esto se requiere).

No Permita que los niños monten el mueble.

Mantenga los artículos más pesados en los cajones de abajo.

Consejos Útiles (página 2)

- Abra su artículo en el área donde usted planea utilizarlo para evitar levantar y moverlo menos
- Identificar, ordenar y contar las piezas antes de intentar ensamblar
- Las clavijas de compresión se golpean con un martillo
- Las diapositivas están marcadas con una R (derecha) y L (izquierda) para la colocación correcta
- Asegúrese de que siempre este el punto localizado en la parte superior de bloqueador de leva este volteado hacia borde exterior
- Utilizar todos los clavos para el panel de atrás y distribuirlos por igual
- El panel de atrás debe utilizarse para asegurarse de que la unidad quede fija y firme
- No use químicas fuertes ni limpiadores abrasivos en este artículo
- Nunca empuje, tire ni arrastre los muebles

Antes de Que Empieces (página 3)

- Lea cuidadosamente cada paso y siga el orden correcto

- Separar y contar todas sus piezas y hardware

- Dése suficiente espacio para el proceso de ensamble

- Tenga las siguientes herramientas: destornillador de cabeza plana, #2 cabeza Phillips

Destornillador y martillo

- Precaución: Si usa un taladro electrónico o un destornillador eléctrico para atornillar, por favor asegúrese que deje de atornillar cuando el tornillos este apretado. Fallar hacer esto puede causar barrer el tornillo.

Sistema de fijar el bloqueo de leva (página 3)

Esta sistema de fijar el bloqueo de leva sera usado en todo el proceso ensamble.

Identificación de los Paneles (Página 4-6)

Este no es el tamaño real

- (A) superior riel
- (B) panel superior
- (C) panel izquierdo
- (D) panel lateral derecho
- (E) partición izquierda
- (F) partición derecha
- (G) particion de la conejera izquierda
- (H) tablero de la conejera correcto
- (I) repisa
- (J) repisa
- (K) repisa ajustable
- (L) tabla izquierda inferior
- (M) panel derecho de abajo
- (N) base
- (O) delantal
- (P) delantal chico
- (Q) delantal medio
- (R) espaciador izquierda
- (S) espaciador derecha
- (T) panel trasero superior
- (U) panel trasero inferior
- (V) panel trasero medio

Número de referencia de la bolsa de herrajes:

27121335COM0CS

Lista de Piezas (Página 8)

Tamaño real

- (1) peron de la leva
- (2) cerradura de la leva
- (3) clavija de madera
- (4) clavija de madera
- (5) tornillo
- (6) tornillo
- (7) tornillo
- (8) peron de la leva
- (9) soporte de repisa

Este no es el tamaño real

- (10) soporte para la pared
- (11) etiqueta de advertencia

Página 9

- 1.1 Atornille (1) dentro de (A), (B), (C) & (D) como se ilustra.
- 1.2 Insertar (3) dentro de (C) & (D) como se ilustra.
- 1.3 Insertar (4) dentro de (B) como se ilustra.

Página 10

- 2.1 Atornille (1) dentro de (E), (F), (G) & (H) como se ilustra.
- 2.2 Insertar (3) dentro de (E), (F), (G) & (H) como se ilustra.

Página 11

- 3.1 Insertar (3) dentro de (I), (J), (L), (M), (N), (P), (Q), (R) & (S) como se ilustra.

Página 12

- 4.1 Una la parte (A) con (B) con (2) & (8) como se ilustra.

Página 13

- 5.1 Una la parte (O) con (I) con (5) como se ilustra.
- 5.2 Una la parte (P) con (J) con (5) como se ilustra.

Página 14

- 6.1 Conectar (G), (I), (J) & (L) juncons por (2) como se ilustra.
- 6.2 Conectar (H), (I), (J) & (M) juncons por (2) como se ilustra.

Página 15

- 7.1 Una la parte (C) con (I) & (L) con (2) com o se ilustra.
- 7.2 Una la parte (E) con(J) & (L) con (2) com o se ilustra.
- 7.3 Una la parte (F) con (J) & (M) con (2) com o se ilustra.
- 7.4 Una la parte (D con (I) & (M) con (2) com o se ilustra.

Página 16

- 8.1 Conectar (E), (F) & (N) con (2) com o se ilustra.

Página 17

- 9.1 Una la parte (A) & (B) con (C), (D), (E) & (F) con (2) com o se ilustra.

Página 18

- 10.1 Una la parte (O), (P) & (Q) con (A) con (5) com o se ilustra.
- 10.2 Una la parte (R) con (E) con (5) com o se ilustra.
- 10.3 Una la parte (S) con (F) con (5) com o se ilustra.

Página 19

- 11.1 Una la parte (T), (U) & (V) con subconjunto con (6) com o se ilustra.

Página 20

- 12.1 Insertar (K) con (E) & (F) con (9) como se ilustra.

Página 21

- 13.1 Una la parte (T), (U) con subconjunto con (6) com o se ilustra.

Página 22

- 14.1 Una la parte fireplace con (R) & (S) con (7) com o se ilustra.

Página 23

- 15.1 Una la parte (10) con (N) con (7) com o se ilustra.

Página 24

- 16.1 Una la parte (V) con subconjunto con (6) com o se ilustra.

Página 25

ANTES DE CONECTAR LA UNIDAD A UNA TOMA DE CORRIENTE ELÉCTRICA

Por favor lea detenidamente y siga las instrucciones y advertencias de seguridad en el "Manual Operativo para Propietarios de Chimenea " para funcionar su chimenea.

ADVERTENCIA

SI NO SIGUE LA INFORMACIÓN EN EL MANUAL OPERATIVO PARA PROPIETARIOS DE CHIMENEA, UNA DESCARGA ELÉCTRICA O UN INCENDIO PUEDE RESULTAR EN DAÑO DEL PRODUCTO, LESIONES PERSONALES O MUERTE.

ADVERTENCIA

Riesgo de muerte o lesión. Esta unidad debe ser colocada frente a una pared y debe ser instalada por lo menos a la misma altura que una televisión.

Para permitir una ventilación adecuada del calentador, esta unidad debe ubicarse a un mínimo de 1-1/2" de distancia de una pared posterior.

Página 26 & 27

CARGA MAXIMA

Esta unidad ha sido diseñada para soportar la carga máxima anotada. El exceder estos límites puede causar inestabilidad, colapsarse y/o causar serias lesiones.

Atención: Aplique la pegatina de advertencia de su televisor en la unidad, así siempre tendrá disponible la información sobre el peso del modelo y los límites de tamaño del televisor.

Tamaño máximo del televisor: pantalla plana de 70"

Pegue la etiqueta de advertencia en el centro del panel superior como se muestra, asegúrese de que la TV cubra la etiqueta antes de pegarla. Usted no podrá quitar la etiqueta una vez que se esta se aplique en el panel superior.

Página 21

Registre su producto para recibir lo siguiente:

- * Detalles de nuevas tendencias - Vistazo a lo nuevo
- * Encuestas - aloc su voz entre su comunidad
- * Códigos de ofertas y descuentos exclusivos
- * Fácil y rápido servicio de partes de remplace

Para registrar su producto, visite ameriwoodhome.com

Clasificación de 5 estrellas

Visite el sitio web de su tienda local, califique su comprado y denos sus comentarios!

Nos gustaría enviar un gran "Agradecimiento" a todos nuestros clientes por tomarse el tiempo de ensamblar este producto de Ameriwood Home, y por darnos sus valiosos comentarios.

Gracias

Couverture Avant

CE LIVRET D'INSTRUCTION CONTIENT DES INFORMATIONS **IMPORTANTES** SUR LA SÉCURITÉ. VEUILLEZ LIRE ET GARDER POUR UNE RÉFÉRENCE FUTURE

Ne retournez pas ce produit! Contactez notre équipe de service à la clientèle amicale d'abord pour obtenir de l'aide.

Appelez-nous: 1-800-489-3351 (sans frais) du Lundi au Vendredi de 9h à 17h Heure Centrale

Visitez: www.ameriwoodhome.com

ATTENTION

Le meuble peut basculer et causer des blessures graves ou la mort.

Ancrer le meuble à une planche murale dans le mur (si indiqué).

Ne laissez pas les enfants grimper sur le meuble.

Placez les articles lourds sur les étagères ou dans les tiroirs inférieurs.

Astuces Utiles (page 2)

-Ouvrez votre article dans la zone que vous prévoyez de le garder pour moins de levage lourd

-Identifier, trier et compter les pièces avant d'essayer d'assembler

-Les goujons de compression sont taraudés avec un Marteau

-Les glissières sont marquées d'un R (droit) et d'un L (gauche) pour un bon placement

-Assurez-vous toujours de faire face la pointe situé sur le haut de la Serrure de Came vers le bord extérieur

-Utiliser tous les clous fournis pour le panneau arrière et les répartir également

-Le panneau arrière doit être utilisé pour vous assurer que votre appareil est robuste

-N'utilisez pas de produits chimiques agressifs ou de nettoyeurs abrasifs sur cet appareil

-Ne jamais pousser, tirer, ou faire glisser votre meuble

Avant de Commencer (page 3)

-Lisez attentivement chaque étape et suivez le bon ordre

-Séparez et comptez toutes vos pièces et matériaux

-Donnez-vous suffisamment de place pour l'assemblage

-Avoir les outils suivants: tournevis à tête plate, #2 tournevis Phillips, et Marteau

-Attention: Si vous utilisez une perceuse électrique ou un tournevis électrique pour visser, veillez à ralentir et arrêter lorsque la vis est bien serrée. Le non-respect de cette consigne peut endommager la vis.

Système de Fixation de Came (page 3)

Ce Système de Fixation de Came sera utilisé tout au long de l'assemblage

Identification des matériaux (Page 4-6)

Pas de taille réelle

- (A) rail dessus
- (B) dessus
- (C) panneau gauche
- (D) panneau droit
- (E) cloison gauche
- (F) cloison droite
- (G) partition de la huche gauche
- (H) bon panneau de la huche
- (I) tablette
- (J) tablette
- (K) tablette réglable
- (L) fond gauche
- (M) fond droit
- (N) dessous
- (O) tablier
- (P) petit tablier
- (Q) tablier centre
- (R) espaceur gauche
- (S) espaceur droit
- (T) panneau arrière supérieur
- (U) panneau arrière inférieur
- (V) panneau arrière central

Numéro de référence du sac de quincaillerie:

27121335COM0CS

Liste des pièces (Page 8)

Taille réelle

- (1) boulon de came
- (2) serrure de came
- (3) goujon en bois
- (4) goujon en bois
- (5) vis
- (6) vis
- (7) vis
- (8) boulon de came
- (9) support de tablette

Pas de taille réelle

- (10) support mural
- (11) avertissement étiquette

Page 9

- 1.1 Vissez (1) dans (A), (B), (C) & (D) omme illustré.
- 1.2 Insérer (3) dans (C) & (D) omme illustré.
- 1.3 Insérer (4) dans (B) omme illustré.

Page 10

- 2.1 Vissez (1) dans (E), (F), (G) & (H) omme illustré.
- 2.2 Insérer (3) dans (E), (F), (G) & (H) omme illustré.

Page 11

- 3.1 Insérer (3) dans (I), (J), (L), (M), (N), (P), (Q), (R) & (S) omme illustré.

Page 12

- 4.1 Attacher (A) à (B) avec (2) & (8) omm e illustré.

Page 13

- 5.1 Attacher (O) à (I) avec (5) omme illustré.
- 5.2 Attacher (P) à (J) avec (5) omme illustré.

Page 14

- 6.1 Connecter (G), (I), (J) & (L) ensemble par (2) omm e illustré.
- 6.2 Connecter (H), (I), (J) & (M) ensemble par (2) omm e illustré.

Page 15

- 7.1 Attacher (C) à (I) & (L) avec (2) omm e illustré.
- 7.2 Attacher (E) à (J) & (L) avec (2) omm e illustré.
- 7.3 Attacher (F) à (J) & (M) avec (2) omm e illustré.
- 7.4 Attacher (D) à (I) & (M) avec (2) omm e illustré.

Page 16

- 8.1 Connecter (E), (F) & (N) avec (2) omm e illustré.

Page 17

- 9.1 Attacher (A) & (B) à (C), (D), (E) & (F) avec (2) omm e illustré.

Page 18

- 10.1 Attacher (O), (P) & (Q) à (A) avec (5) omm e illustré.
- 10.2 Attacher (R) à (E) avec (5) omm e illustré.
- 10.3 Attacher (S) à (F) avec (5) omm e illustré.

Page 19

- 11.1 Attacher (T), (U) & (V) à sous-ensemble avec (6) omm e illustré.

Page 20

- 12.1 Insérer (K) à (E) & (F) avec (9) omme illustré.

Page 21

- 13.1 Attacher (T), (U) à sous-ensemble avec (6) omm e illustré.

Page 22

- 14.1 Attacher fireplace à (R) & (S) avec (7) omm e illustré.

Page 23

- 15.1 Attacher (10) à (N) avec (7) omm e illustré.

Page 24

- 16.1 Attacher (V) à sous-ensemble avec (6) omm e illustré.

Page 25

AVANT DE BRANCHER L'APPAREIL À UNE PRISE ÉLECTRIQUE MURALE

Veillez lire et suivre attentivement les instructions et les mises en garde de sécurité dans le "Mode d'emploi du Manuel du propriétaire du Foyer" pour faire fonctionner votre foyer.

MISE EN GARDE

SI LES INFORMATIONS DANS LE MANUEL DU PROPRIÉTAIRE DU FOYER NE SONT PAS SUIVIES ATTENTIVEMENT, UN CHOC ÉLECTRIQUE OU UN INCENDIE PEUT SE PRODUIRE ET CAUSER DES DOMMAGES MATÉRIELS, DES BLESSURES, OU DES PERTES DE VIES.

AVERTISSEMENT

Danger de mort ou de blessures graves. Cette surface doit être placée contre un mur fixé en place au moins aussi grand que la télévision.

Pour permettre une bonne ventilation du radiateur, cet appareil doit être situé à 1-1/2" d'un mur arrière.

Page 26 & 27

CHARGES MAXIMALES

Ce meuble a été conçu pour supporter les charges maximales indiquées. En excédant ces limites de charge, le meuble pourrait devenir instable, s'effondrer, et/ou causer des blessures graves.

Remarque: Veuillez apposer l'étiquette d'avertissement du téléviseur sur votre appareil ainsi vous aurez toujours les limites de poids du modèle et la taille de votre téléviseur.

Taille maximale du téléviseur: 70" écran plat.

Appliquez l'étiquette de mise en garde au centre du panneau supérieur comme montré. Assurez-vous que le téléviseur couvre l'étiquette utilisée. Vous ne pourrez pas retirer l'étiquette après l'avoir appliquée sur le panneau supérieur.

Page 21

Enregistrez votre produit pour recevoir les éléments suivantes:

- * Détails sur les nouvelles tendances - un aperçu sur les nouveautés
- * Sondages - avoir une voix au sein de notre communauté
- * Offres exclusives et codes promo
- * Service de pièces de rechange rapide et facile

Pour enregistrer votre produit, visitez ameriwoodhome.com

5 Étoiles

Visitez le site Web de votre détaillant local, évaluez votre produit acheté et laissez-nous quelques commentaires !

Nous tenons à offrir un grand "Merci" à tous nos clients pour avoir pris le temps d'assembler ce produit "Ameriwood Home", et de nous donner vos commentaires précieux.

Merci